

Solid State Relays G3R/G3RD

Refer to *Warranty and Application Considerations* (page 1), *Safety Precautions* (page 4), and *Technical and Safety Information* (page 6).

Compact SSRs Ideal for Built-in Applications

- Vertical, compact SSRs with an operation indicator offered in versatile variations.
- High dielectric strength of 2,500 VAC for 2-A models.
- High-voltage DC version also available.
- Certified by UL and CSA.



Model Number Structure

■ Model Number Legend

G3R-□□□□□-□
1 2 3 4 5 6 7

1. Basic Model Name

G3R: Solid State Relay

2. Rated Load Power Supply Voltage

1: 100 VAC
2: 200 VAC

3. Rated Load Current

02: 2 A

4. Terminal Type

P: PCB terminals

5. Isolation Method

Blank: Phototriac/photocoupler isolation with zero cross function
L: Phototriac/photocoupler isolation without zero cross function

6. Operation Indicator

N: Equipped with operation indicator

7. Certification

US: Certified by UL and CSA

G3RD-□□□□□-□
1 2 3 4 5 6 7

1. Basic Model Name

G3R: Solid State Relay

2. Rated Output Load

D: Switches DC loads

3. Rated Load Power Supply Voltage

1: 100 VDC
X: 50 VDC

4. Rated Load Current

01: 1.5 A
02: 2 A

5. Terminal Type

P: PCB terminals

6. Operation Indicator

N: Equipped with operation indicator

7. Certification

US: Certified by UL and CSA

Ordering Information

■ List of Models

Terminals	Isolation	Zero cross function	Indicator	Rated output load	Rated input voltage	Model
PCB	Phototriac	Yes	Yes	2 A at 100 to 120 VDC (See note 1.)	5, 12, 24 VDC	G3R-102PN-US
		No				G3R-102PLN-US
		Yes		2 A at 100 to 240 VAC (See note 2.)		G3R-202PN-US
		No				G3R-202PLN-US
	Photocoupler	---	Yes	1.5 A at 5 to 110 VDC		G3RD-101PN-US
				2 A at 4 to 48 VDC (See note 3.)		G3RD-X02PN-US

- Note:**
1. Product is labelled "125 VAC".
 2. Product is labelled "250 VAC".
 3. Product is labelled "50 VDC".
 4. When ordering, specify the rated input voltage.

Specifications

■ Ratings (at an Ambient Temperature of 25°C)

Input (AC Output With Zero Cross Function)

Model	Rated voltage	Operating voltage	Impedance	Voltage level	
				Must operate voltage	Must release voltage
G3R-102PN-US	5 VDC	4 to 6 VDC	250 Ω±20%	3.5 VDC max.	0.375 VDC min.
G3R-202PN-US	12 VDC	9.6 to 14.4 VDC	600 Ω±20%	8.4 VDC max.	0.9 VDC min.
	24 VDC	19.2 to 28.8 VDC	1.5 kΩ±20%	16.8 VDC max.	1.8 VDC min.

Input (AC Output Without Zero Cross Function, DC Output)

Model	Rated voltage	Operating voltage	Impedance	Voltage level	
				Must operate voltage	Must release voltage
G3R-102PLN-US	5 VDC	4 to 6 VDC	300 Ω±20%	3.5 VDC max.	0.375 VDC min.
G3R-202PLN-US	12 VDC	9.6 to 14.4 VDC	750 Ω±20%	8.4 VDC max.	0.9 VDC min.
G3RD-X02PN-US	24 VDC	19.2 to 28.8 VDC	1.5 kΩ±20%	16.8 VDC max.	1.8 VDC min.
G3RD-101PN-US					

Output

Model	Rated load voltage	Applicable load		
		Load voltage range	Load current	Inrush current
G3R-102PN-US	100 to 120 VAC	75 to 132 VAC	0.1 to 2 A	30 A (60 Hz, 1 cycle)
G3R-102PLN-US				
G3R-202PN-US	100 to 240 VAC	75 to 264 VAC	0.1 to 2 A	
G3R-202PLN-US				
G3RD-X02PN-US	4 to 48 VDC	3 to 52.8 VDC	0.01 to 2 A	8 A (10 ms)
G3RD-101PN-US	5 to 110 VDC	3 to 125 VDC	0.01 to 1.5 A	2.5 A (10 ms)

■ Characteristics

Item	G3R-102PLN-US	G3R-102PN-US	G3R-202PLN-US	G3R-202PN-US	G3RD-X02PN/-101PN-US
Operate time	1 ms max.	1/2 of load power source cycle + 1 ms max.	1 ms max.	1/2 of load power source cycle + 1 ms max.	1 ms max.
Release time	1/2 of load power source cycle + 1 ms max.				1 ms max.
Output ON voltage drop	1.6 V (RMS) max.				1.5 V max.
Leakage current	2 mA max. (at 100 VAC)		2 mA max. (at 100 VAC) 5 mA max. (at 200 VAC)		0.1 mA max. (at 50 VDC) 0.1 mA max. (at 125 VDC)
Insulation resistance	100 MΩ min. (at 500 VDC)				
Dielectric strength	2,500 VAC, 50/60 Hz for 1 min				2,500 VAC, 50/60 Hz for 1 min
Vibration resistance	Malfunction: 10 to 55 to 10 Hz, 0.75-mm single amplitude				
Shock resistance	Malfunction: 1,000 m/s ²				
Ambient temperature	Operating: -30°C to 80°C (with no icing or condensation) Storage: -30°C to 100°C (with no icing or condensation)				
Certified standards	UL508 File No. E64562, CSA C22.2 (No. 14) File No. 35535				
Ambient humidity	Operating: 45% to 85%				
Weight	Approx. 18 g				

Engineering Data

Load Current vs. Ambient Temperature Characteristics

1-A Load Model

G3RD-101PN-US

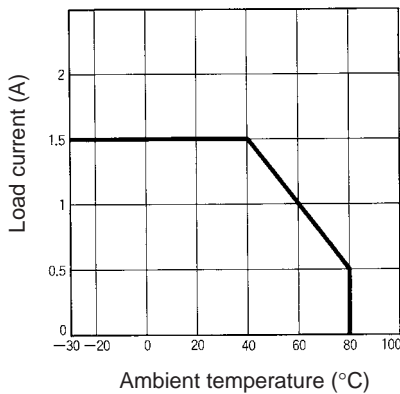

2-A Load Model

G3R-102□-US, G3RD-X02□-US, G3R-202□-US

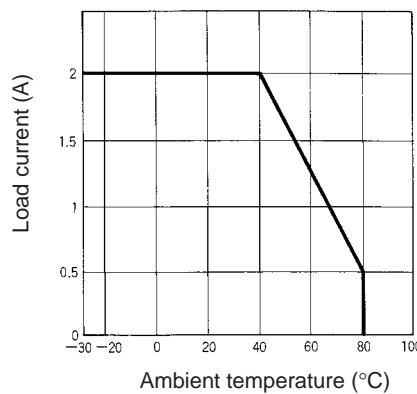

One Cycle Surge Current: Non-repetitive

Non-repetitive (Keep the inrush current to half the rated value if it occurs repetitively.)

G3R-102□-US/-202□-US

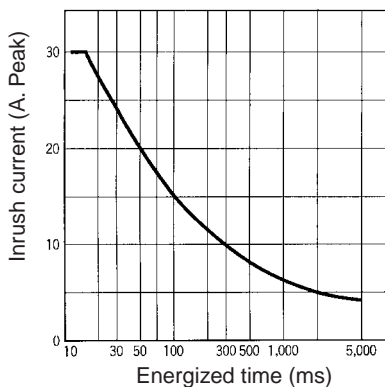

G3RD-101PN-US

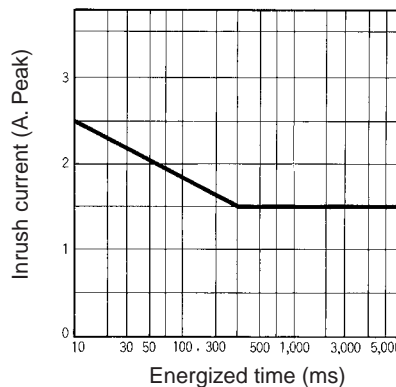

G3RD-X02□-US

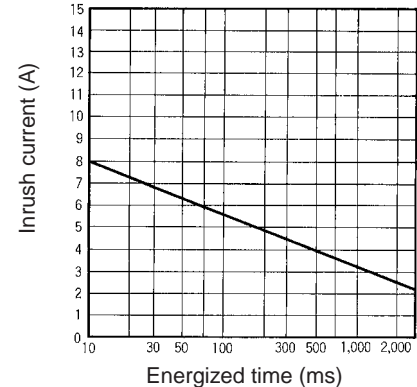

Dimensions

Note: All units are in millimeters unless otherwise indicated.

G3R-102P□-US/-202P□-US
G3RD-101PN-US/-X02PN-US

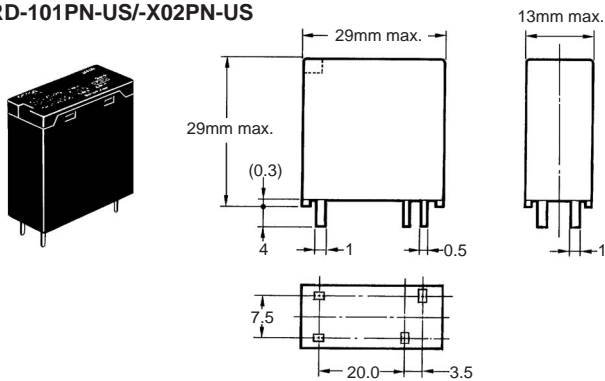

Terminal Arrangement/ Internal Connections (Bottom View)

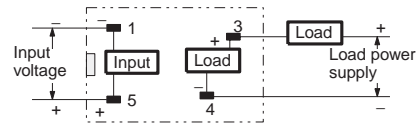

Note: The plus and minus symbols shown in the parentheses are for DC loads.

Mounting Holes

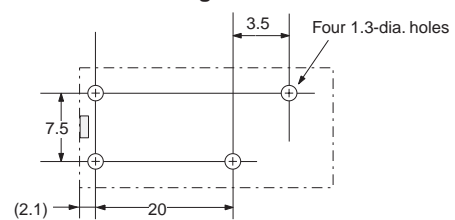

Safety Precautions

■ Precautions for Correct Use

Please observe the following precautions to prevent failure to operate, malfunction, or undesirable effect on product performance.

Connection

The SSR for DC switching a surge can connect to a load regardless of the polarity of the positive and negative output terminals.

Protective Terminal

For AC inductive loads, connect the load terminals of the SSR to a surge absorber (varistor).

ALL DIMENSIONS SHOWN ARE IN MILLIMETERS.

To convert millimeters into inches, multiply by 0.03937. To convert grams into ounces, multiply by 0.03527.