

# MULTIS

The versatile new range of single & multifunction energy meters

2017  
2018



your energy  
our expertise





# Selection guide

## Multifunction meters

### MULTIS m

Single-circuit metering,  
measurement &  
analysis

Which  
application ?





Which  
functions

	Ammeter				Voltmeter
					
	MULTIS Im15 <i>p. 4</i>	MULTIS Im15 <i>p. 4</i>	MULTIS Im35 <i>p. 4</i>	MULTIS Im35 <i>p. 4</i>	Multis Vm15 <i>p. 4</i>
<b>Measurements</b>					
I	•	•	•	•	
U					•
F					
V					
P, Q, S, Ea, ER, PF					
Hour run					
Import/export (Active energy & reactive energy)					
THD (V & I)					
AC network	LV single phase	LV single phase	LV three phase	LV three phase	LV single phase
Measurement range between phases					
Accuracy	1%	1%	1%	1%	1%
CT secondary programmable	with 1 A secondary	with 5 A secondary	with 1 A secondary	with 5 A secondary	
PT programmable					•
Max demand indication					
<b>Communication</b>					
Type					
<b>Auxiliary power supply</b>					
Self supplied	no	no	no	no	no
Voltage	40 ... 300 VAC/DC (+/-5%)	40 ... 300 VAC/DC (+/-5%)	40 ... 300 VAC/DC (+/-5%)	40 ... 300 VAC/DC (+/-5%)	40 ... 300 VAC/DC (+/-5%)
Frequency	45 ... 65 Hz	45 ... 65 Hz	45 ... 65 Hz	45 ... 65 Hz	45 ... 65 Hz
Consumption	< 3 VA	< 3 VA	< 3 VA	< 3 VA	< 3 VA
<b>Case</b>					
Type	panel mounting	panel mounting	panel mounting	panel mounting	panel mounting
Dimensions (H x W x D) (mm)	96 x 96 x 27	96 x 96 x 27	96 x 96 x 27	96 x 96 x 27	96 x 96 x 27
Panel cut out dimensions (H x W) (mm)	92 + 0.8 x 92 + 0.8	92 + 0.8 x 92 + 0.8	92 + 0.8 x 92 + 0.8	92 + 0.8 x 92 + 0.8	92 + 0.8 x 92 + 0.8
Weight (Without Packing Box)	0.31 kg	0.31 kg	0.31 kg	0.31 kg	0.31 kg
Front protection rating	IP50	IP50	IP50	IP50	IP50
<b>Operating conditions</b>					
Operating temperature	0 ... +50°C	0 ... +50°C	0 ... +50°C	0 ... +50°C	0 ... +50°C
<b>Reference</b>					
Multis	192J 9025	192J 9024	192J 9027	192J 9026	192J 9014

Which dimensions ?

Communication or pulse output ?

Voltmeter	Multifunction meter				Dual source	Single source
						
<b>MULTIS Vm35</b> <i>p. 4</i>	<b>MULTIS Lm25</b> <i>p. 8</i>	<b>MULTIS Lm46</b> <i>p. 10</i>	<b>MULTIS Lm55</b> <i>p. 12</i>	<b>MULTIS Lm56</b> <i>p. 12</i>	<b>MULTIS Lm35</b> <i>p. 6</i>	<b>MULTIS Lm42</b> <i>p. 6</i>
	•	•	•	•	•	via COM
•	•	•	•	•	•	via COM
	•	•	•	•	•	via COM
•	•	•	•	•	•	via COM
		•	•	•	•	+/- Ea
	•	•	•	•	•	via COM
		•	•	•	•	via COM
			•	•	•	via COM
LV three phase	LV three phase	LV three phase + neutral	LV or HV three phase + neutral	LV or HV three phase + neutral	1 phase 2 wire / 3 phase 3 wire / 3 phase 4 wire	1 phase 2 wire / 3 phase 3 wire / 3 phase 4 wire
			110 ... 440 VAC	110 ... 440 VAC	55 ... 498 V LL	55 ... 498 V LL
1%	1%	1%	1%	0.50%	Class 1	Class 1
	1 A or 5 A	1 A or 5 A	1 A or 5 A	1 A or 5 A	1 A or 5 A	1 A or 5 A
•	•	•	•	•	110 V L-L / 230 V L-L and 415 V L-L	110 V L-L / 230 V L-L and 415 V L-L
		For current, KVA and KW	For current, KVA and KW	For current, KVA and KW	For current, KVA and KW	For current, KVA and KW
		MODBUS RS485	MODBUS RS485	MODBUS RS485	MODBUS RS485	MODBUS RS485
no	no	no	no	no	yes	yes
40...300 VAC/DC (+/-5%)	40...300 VAC/DC (+/-5%)	40...300 VAC/DC (+/-5%)	100...250 VAC/DC+/-10%	100...250 VAC/DC+/-10%	60 V – 300 V AC / DC	60 V – 300 V AC / DC
45 ... 65 Hz	45 ... 65 Hz	45 ... 65 Hz	45 ... 65 Hz	45 ... 65 Hz	50 Hz / 60 Hz	50 Hz / 60 Hz
< 3 VA	< 3 VA	< 4 VA	< 4 VA	< 4 VA	< 4 VA	< 4 VA
panel mounting	panel mounting	panel mounting	panel mounting	panel mounting	panel mounting	panel mounting
96 x 96 x 27	96 x 96 x 55	96 x 96 x 55	96 x 96 x 80	96 x 96 x 80	96 x 96 x 55	96 x 96 x 80
92 + 0.8 x 92 + 0.8	92 + 0.8 x 92 + 0.8	92 + 0.8 x 92 + 0.8	92 + 0.8 x 92 + 0.8	92 + 0.8 x 92 + 0.8	92 + 0.8 x 92 + 0.8	92 + 0.8 x 92 + 0.8
0.31 kg	0.32 kg	0.32 kg	0.70 kg	0.70 kg	0.32 kg	0.32 kg
IP50	IP50	IP50	IP54	IP54	IP54	IP54
0 ... +50°C	0 ... +50°C	0 ... +50°C	0 ... +50°C	0 ... +50°C	-10 ... +55°C	-10 ... +55°C
<b>192J 9015</b>	<b>192J 9101</b>	<b>192J 9112</b>	<b>192J 9200</b>	<b>192J 9201</b>	<b>192J 9114</b>	<b>192J 9113</b>



# MULTIS *Im15/Im35/Vm15/Vm35*

## Measurement devices

one or three phases - current, voltage measurement - 96 x 96 mm

Single-circuit metering,  
measurement &  
analysis



### The solution for

- > Industry
- > Infrastructure



### Function

The single and three phase Socomec MULTIS m range, 96 x 96 mm ensures an accurate measurement of electrical parameters I and V.

### Applications

- The **MULTIS Im15** is a single phase digital ammeter for AC network.
- The **MULTIS Im35** is a 3 phase digital ammeter for AC network.
- The **MULTIS Vm15** is a single phase digital voltmeter for AC network.
- The **MULTIS Vm35** is a 3 phase digital voltmeter for AC network.

### Advantages

- Made of sturdy polycarbonate housing.
- Resistant to high shock level and adapted for working in a high pollution environment.
- Adapted for 3 phase 3 wire or 3 phase 4 wire network types.
- Bright LED 1 line, 4 digit, 14 mm high display.
- On site selection of auto scroll for Im35.

## ■ Ammeter MULTIS Im15 / Im35

### Dimensions

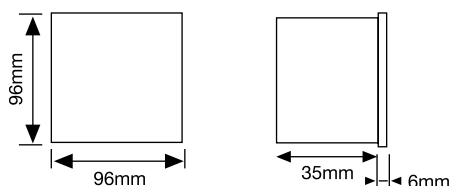

Type	panel mounting
Dimensions W x H x D	96 x 96 x 40 mm
Panel cut out dimensions (H x W)	92+0.8 mm x 92+0.8 mm
Front protection rating	IP50
Weight	0.31 kg

### Electrical characteristics

Measurements	
AC network	LV single + Three phase
Current range	10...120% of rated value
Frequency	45 ... 65Hz
Accuracy	1%
Nominal input current range	1A or 5A AC RMS (to be specified while order)
Auxiliary power supply	
AUX supply	40 ... 300 V AC/DC (+5%)
Frequency	45 ... 65 Hz
VA burden	3 VA
Operating conditions	
Operating temperature	0 ... +50 °C

# MULTIS *Im15/Im35/Vm15/Vm35*

Measurement devices

one or three phases - current, voltage measurement - 96 x 96 mm

## Connection

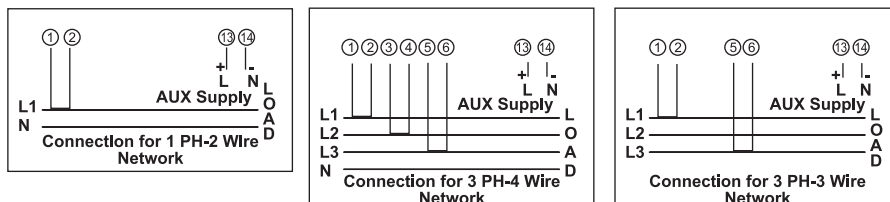

## References

Auxiliary supply	Frequency	CT	MULTIS Im15 Reference	MULTIS Im35 Reference
40 ... 300 VAC/DC	45 ... 60 Hz	1 A	192J 9025	192J 9027
		5 A	192J 9024	192J 9026

## Voltmeter MULTIS Vm15 / Vm35

### Dimensions

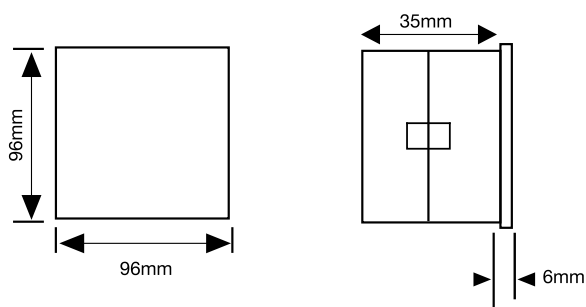

Type	panel mounting
Dimensions W x H x D	96 x 96 x 40 mm
Panel cut out dimensions (H x W)	92+0.8 mm x 92+0.8 mm
Front protection rating	IP50
Weight	0.31 kg

### Electrical characteristics

Measurements	
AC network	LV single + Three phase
Voltage range	57... 600 VAC
Accuracy	± 1%
Voltage overload	2X rated value for 1s, repeated 10 times at 10s interval
Auxiliary power supply	
AUX supply	40 ... 300 V AC/DC (+5%)
Frequency	45 ... 65 Hz
VA burden	3 VA approx
Operating conditions	
Operating temperature	0 ... +50 °C

## Connection

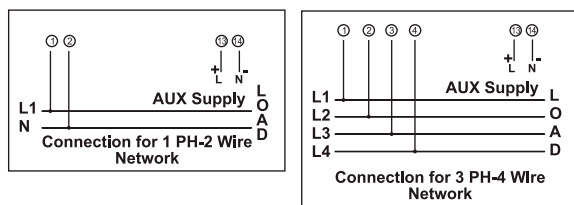

## References

Auxiliary supply	Frequency	MULTIS Vm15 Reference	MULTIS Vm35 Reference
40 ... 300 VAC	45 ... 65 Hz	192J 9014	192J 9015





# MULTIS Lm35/Lm42

Energy meters with port

three phases - dual source and single source - 96 x 96 mm

Single-circuit metering,  
measurement &  
analysis



MULTIS Lm35



MULTIS Lm42

## The solution for

- > Industry
- > Infrastructure



## Function

MULTIS Lm35 & Lm42 are new versatile range of dual and single source energy meters with display of all energy and power parameters (only in Lm42, all the values except energy are accessed via RS485 port).

## Applications

- MULTIS Lm35 is an LCD digital panel meter, with dual source energy metering with a 96 x 96 mm display and built in RS485 port for measurement of utility mains as well as DG emergency source power consumption, with programmable CT PT, encompassing all energy and power parameters, across 4 quadrants. MULTIS Lm42 is only for mains utility source energy measurements, with the other parameters via RS485 port

## Advantages

- Made of sturdy polycarbonate housing.
- Resistant to high shock level and adapted for working in a high pollution environment.
- Multis Lm35 a highly adapted feature rich dual source, energy metering device, incorporating various power monitoring parameters.
- At a time upto 3 parameters are displayed on the LCD screen, balance in scroll mode.
- There are additional indications for the max demand threshold for power and energy.
- Multis Lm42 is an energy measurement device, with key power parameters accessible through the integrated RS485 port.
- Lm42 is designed for 4 quadrant energy measurement.

## Dimensions

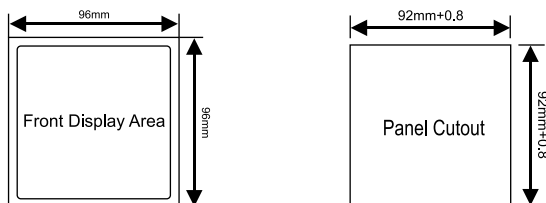

Type	panel mounting
Dimensions W x H x D	96 x 96 mm
Panel cut out dimensions (H x W)	92+0.8 mm x 92+0.8 mm
Front protection rating	IP50
Weight	0.32 kg

## Connection

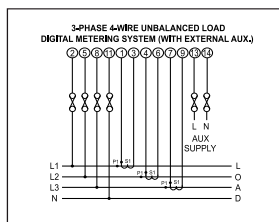
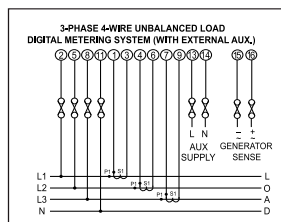

## Electrical characteristics

Auxiliary power supply	
Voltage	60 ... 300 V AC/DC
Frequency	50 ... 60 Hz
Consumption	6 VA with RS485 port
Operating conditions	
Operating Temperature	-10 ... +55 °C

## Measurement

Current measurements	
System CT secondary	1 A & 5 A
System CT primary	from 1 A up to 9999 A
Accuracy	± 1.0%
Voltage measurements	
Nominal input voltage	P-N > 250V, P-P > 500V
System PT secondary	110V L-L / 230V L-L / 415V L-L
System PT primary	110V L-L / 230V L-L / 415V L-L
Max. continuous input voltage	+ 20% of rated value
Accuracy	± 1.0%
Frequency measurement	
Energy accuracy	active
Reactive energy	± 1.0%

## Electrical parameter

Lm35 Dual Source meter
KWh, KVARh, KVAh
KW, KVAR, KVA
PF
Demand: for current, kVA and kW (including max demand values)
On hrs, run hrs, interupts, rpm, old values
Current
Voltage
Neutral current
THD V&I
Reversal of phase
Reversal of current
Phase absence indication

Lm42 <sup>(1)</sup> Single Source meter
KWh, KVARh, KVAh,
KW, KVAR, KVA
4 quadrant import export
PF
Demand: for current, kVA and kW (including max demand values)
On hrs, run hrs, interupts, rpm, old values
Current
THD V&I
Voltage
Neutral current

(1) Except kWh rest all parameters is possible to observe via RS485.

## References

Auxiliary supply	Frequency	MULTIS Lm35 Reference	MULTIS Lm42 Reference
60....300 VAC/DC	45 ... 65 Hz	192J 9114	192J 9113



# MULTIS Lm25

## Measurement devices

three phases - VAF meter - 96 x 96 mm

Single-circuit metering,  
measurement &  
analysis



MULTIS Lm25

multi\_0683\_a

### The solution for

- > Industry
- > Infrastructure



### Function

The three phase Socomec Multis Lm25 range, 96 x 96 mm ensures an accurate measurement of electrical parameters I, V and Hz.

### Applications

- **MULTIS Lm25** is a digital LV and HV three phase measurement device. It displays three phase voltage / current / frequency.

### Advantages

- Made of sturdy polycarbonate housing.
- Resistant to high shock level and adapted for working in a high pollution environment.
- Suitable for 3 phase 3 wire or 3 phase 4 wire network types.
- Both CT as well as PT are programmable.
- The measurement chain comprises system current, voltage and frequency, with min and max values.
- Both line as well as phase voltages are displayed, additional RPM and run hrs also get displayed.
- Advanced features include password protection and a high overload withstand capability
- Bright LED display spans 3 line, 4 digits, 14 mm high.



#### Dimensions

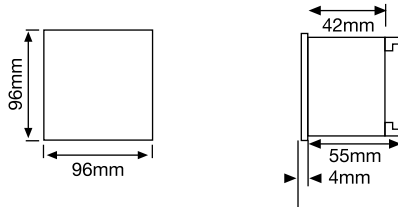

Type	panel mounting
Dimensions W x H x D	96 x 96 x 46 mm
Panel cut out dimensions (H x W)	92+0.8 mm x 92+0.8 mm
Front protection rating	IP50
Weight	0.32 kg

#### Connection

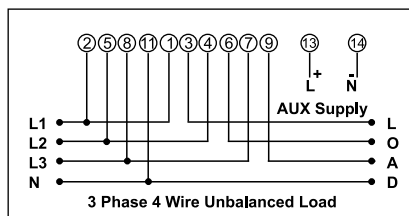

#### Electrical characteristics

##### Auxiliary power supply

AUX supply	40 V ... 300 VAC-DC ( $\pm 5\%$ )
Frequency	45 ... 65 Hz
VA burden	3 VA

##### Operating conditions

Operating temperature	0 ... +50 °C
-----------------------	--------------

#### Measurement

##### Current measurements

Nominal input current	5 A AC
System CT secondary	1 A & 5 A
System CT primary	from 1 A up to 9999 A
Max. continuous input current	120 % of rated value
Accuracy	$\pm 1.0 \%$

##### Voltage measurements

Nominal input voltage	PN-290 V , PP-500 V
System PT secondary	100V LL to 500V LL
System PT primary	100V LL to 692K LL
Max. continuous input voltage	120% of rated value
Accuracy	$\pm 1.0\%$

##### Frequency measurement

Frequency range	45 ... 65 Hz
Accuracy	$\pm 0.5 \%$

#### References

Auxiliary supply	Frequency	MULTIS Lm25 Reference
40 ... 300 VAC	45 ... 65 Hz	192J 9101



# MULTIS Lm46

## Measurement devices

three phases - all electrical parameters - 96 x 96 mm

Single-circuit metering,  
measurement &  
analysis



MULTIS Lm46

multi\_064\_a

### The solution for

- > Industry
- > Infrastructure



### Function

The Socomec MULTIS Lm46 range, 96 x 96 mm ensures an accurate measurement of all electrical parameters I, V, Hz, P, Q, S & E.

### Applications

- **MULTIS Lm46** is a digital three phase multifunction meter for measuring electrical value like voltage, current, energy with on site programmable functions of CT / PT, RS485 modbus Communication.

### Advantages

- Made of sturdy polycarbonate housing.
- Resistant to high shock level and adapted for working in a high pollution environment.
- Suitable for 3 phase 3 wire or 3 phase 4 wire network types.
- Both CT as well as PT are programmable.
- A very comprehensive parameter profile for energy measurement and power monitoring, that includes phase angle for current and voltage.
- Active, reactive as well as apparent powers are displayed.
- RPM, run hrs, ON hrs and interrupt are indicated.
- Key demand parameters are measured, including current, KVA, KW with nominal as well as maximum values.
- Characterized by high overload withstand, password protection.
- With annunciation of -ve sign display for the active power in 2nd or 3rd quadrant.

### Dimensions

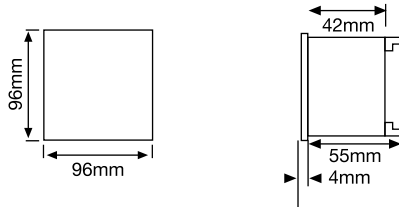

Type	panel mounting
Dimensions W x H x D	96 x 96 x 46 mm
Front IP	IP50
Rear IP	IP20
Weight	0.32 kg

### Connection

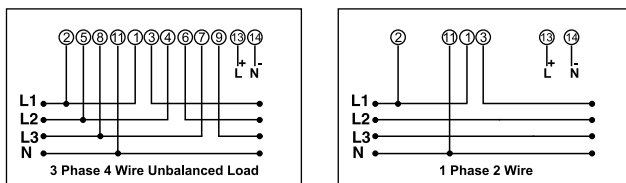

### Electrical characteristics

Auxiliary power supply	
Voltage	40 V ... 300 VAC-DC ( $\pm 5\%$ )
Frequency	45 ... 65 Hz
Consumption	< 4 VA approx
Operating conditions	
Operating temperature	0 ... +50 °C

### Measurement

Current measurements	
System CT secondary	1 A & 5 A
System CT primary	from 1 A up to 9999 A
Max. continuous input current	120 % of rated value
Accuracy	$\pm 1.0 \%$
Voltage measurements	
Nominal input voltage	PN-290 V , PP-500 V
System PT secondary	100V LL to 500V LL
System PT primary	100V LL to 692K LL
Max. continuous input voltage	120% of rated value
Accuracy	$\pm 1.0\%$
Frequency measurement	
Frequency range	45 ... 65 Hz
Accuracy	$\pm 0.5 \%$
Energy accuracy	
Active energy	$\pm 1.0\%$
Reactive energy	$\pm 1.0\%$

### References

<b>Auxiliary supply</b> 40 ... 300 VAC	<b>Frequency</b> 45 ... 65 Hz	<b>MULTIS Lm46 Reference</b> 192J 9112
---	----------------------------------	---



# MULTIS Lm55 / Lm56

## Measurement devices

three phases - all electrical parameters - 96 x 96 mm

Single-circuit metering,  
measurement &  
analysis



MULTIS Lm55



MULTIS Lm56

### The solution for

- > Industry
- > Infrastructure



multi\_085\_a multi\_086\_a

## Function

The Socomec MULTIS range is a three phase multifunction measurement device. It measures three phase voltages, current, power, frequency, PF, THD with max demand and Import / Export feature. In addition it also has RS485 communication port.

## Applications

- **MULTIS Lm55 & Lm 56** are digital LV and HV three phase measurement device. They display the most important electrical values needed in an energy efficiency process.

## Advantages

- Made of sturdy polycarbonate housing.
- Resistant to high shock level and adapted for working in a high pollution environment.
- Suitable for 3 phase 3 wire or 3 phase 4 wire network types.
- Both CT as well as PT are programmable.
- A very comprehensive parameter profile for energy measurement and power monitoring, that includes phase angle for current and voltage.
- Active, reactive as well as apparent powers are displayed.
- RPM, run hrs, ON hrs and interrupt are indicated.
- Key demand parameters are measured, including current, KVA, KW with nominal as well as maximum values.
- Characterized by high overload withstand, password protection.
- With annunciation of -ve sign display for the active power in 2nd or 3rd quadrant.
- Dedicated indication for phase rotation error and for the correct phase sequence.
- Versions for CI-1 as well as CI-0.5 class of accuracy.
- Power monitoring via THD on current and voltage.

# MULTIS Lm55 / Lm56

Measurement devices

three phases - all electrical parameters - 96 x 96 mm

## Dimensions

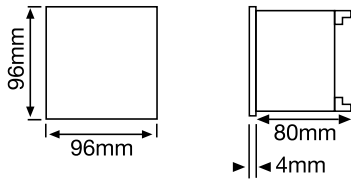

Type	panel mounting
Dimensions W x H x D	96 x 96 x 80 mm
Front IP	IP54
Rear IP	IP20
Weight	0.62 kg

## Connection

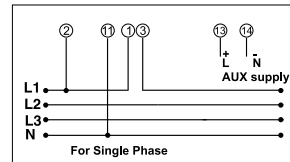
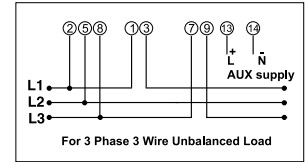
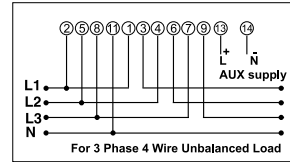

## MULTIS Lm55

### Electrical characteristics

<b>Auxiliary power supply</b>	
Voltage	100V ... 250 VAC - DC ( $\pm 10\%$ )
Frequency	45 ... 66 Hz
Consumption	< 4 VA approx
<b>Operating conditions</b>	
Operating temperature	0 ... +50 °C

### Measurement

<b>Current measurements</b>	
System CT secondary	1 A & 5 A
System CT primary	from 1 A up to 9999 A
Max. continuous input current	120 % of rated value
Accuracy	$\pm 1.0\%$
<b>Voltage measurements</b>	
Nominal input voltage	PN-290 V , PP-500 V
System PT secondary	100V LL to 500V LL
System PT primary	100V LL to 692K LL
Max. continuous input voltage	120% of rated value
Accuracy	$\pm 1.0\%$
<b>Frequency measurement</b>	
Frequency range	40 ... 70 Hz
Accuracy	$\pm 0.2\%$
<b>Energy accuracy</b>	
Active energy	$\pm 1.0\%$
Reactive energy	$\pm 1.0\%$
Apparent energy	$\pm 1.0\%$
Active / reactive / apparent power	$\pm 0.5\%$
Total harmonic distortion	$\pm 1.0\%$

## MULTIS Lm56

### Electrical characteristics

<b>Auxiliary power supply</b>	
Voltage	100V ... 250 VAC - DC ( $\pm 10\%$ )
Frequency	45 ... 66 Hz
Consumption	< 4 VA approx
<b>Operating conditions</b>	
Operating temperature	0 ... +50 °C

### Measurement

<b>Current measurements</b>	
System CT secondary	1 A & 5 A
System CT primary	from 1 A up to 9999 A
Max. continuous input current	120 % of rated value
Accuracy	$\pm 1.0\%$
<b>Voltage measurements</b>	
Nominal input voltage	PN-290 V , PP-500 V
System PT secondary	100V LL to 500V LL
System PT primary	100V LL to 692K LL
Max. continuous input voltage	120% of rated value
Accuracy	$\pm 1.0\%$
<b>Frequency measurement</b>	
Frequency range	40 ... 70 Hz
Accuracy	$\pm 0.2\%$
<b>Energy accuracy</b>	
Active energy	$\pm 0.5\%$
Reactive energy	$\pm 0.5\%$
Apparent energy	$\pm 0.5\%$
Active / reactive / apparent power	$\pm 0.5\%$
Total harmonic distortion	$\pm 1.0\%$

## References

<b>Auxiliary supply</b> 40 ... 300 VAC	<b>Frequency</b> 45 ... 65 Hz	<b>MULTIS Lm55 Reference</b> 192J 9200	<b>MULTIS Lm56 Reference</b> 192J 9201
---	----------------------------------	---	---



# MULTIS L50

Digital panel meter

three phases - via CT up to 6000 A dimensions 96 x 96 mm

**new**



multi\_076\_a\_1\_cat.eps

MULTIS L50

Single-circuit metering,  
measurement &  
analysis

### The solution for

- > Industry
- > Infrastructure



### Strong points

- > Large backlit LCD display
- > Direct display of multimeasurement and metering values
- > RS485 MODBUS communication
- > Inputs/Output for control/ command ou pulses

### Conformity to standards

- > IEC 62053-21 class 1
- > IEC 62053-23 class 2



### Function

The MULTIS L50 is a panel mounted digital meter displaying multi-measurement and energy values directly on its large backlit LCD display. It is designed for utilisation on three-phase or single-phase networks with connection via CT and is suitable for applications of up to 6000 A. The product can be configured by the user via the keypad and the display.

### Advantages

#### Easy to use

Thanks to its large backlit LCD display and its multiple viewing screens with direct pushbutton access, MULTIS L50 provide clear readings and are easy to use.

They directly display a number of multi-measurement and metering values.

#### Advanced functionalities

The MULTIS L50 offers input/output functions as standard and has a pulse output or RS485 MODBUS communication output.

### Principle diagram

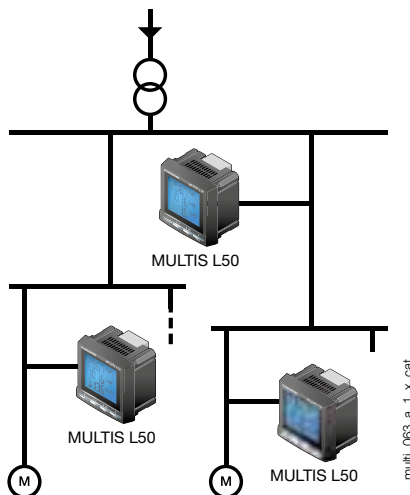

multi\_063\_a\_1\_x\_cat

## Functions

#### Multi-measurement

- Currents
  - instantaneous: I1, I2, I3, In
  - maximum average: I1, I2, I3, In
- Voltages & frequency
  - instantaneous: V1, V2, V3, U12, U23, U31, F
- Power
  - instantaneous: 3P, ΣP, 3Q, ΣQ, 3S, ΣS
  - maximum average: ΣP, ΣQ, ΣS
  - unbalance: U unb
- Power factors
  - instantaneous: 3PF, Σ

#### Metering

- Active energy: ± kWh
- Reactive energy: ± kvarh
- Hours: ⌚

#### Harmonic analysis

- Total harmonic distortion (level 51)
  - Currents: thd I1, thd I2, thd I3
  - Phase-to-neutral voltage: thd V1, thd V2, thd V3
  - Phase-to-phase voltage: thd U12, thd U23, thd U31

#### Communications<sup>(1)</sup>

RS485 with MODBUS protocol

#### Output

- Remote command of device
- Pulse report

#### Inputs

- Remote status device

(1) Available as an option (see the following pages).



### Front panel



1. Backlit LCD display.
2. Direct access key for currents (instantaneous and max. values), current THD.
3. Direct access key for voltages, frequency and voltage THD.
4. Pushbutton for active, reactive, and apparent power (instantaneous and max. values) and power factor.
5. Direct access key for energies, hour meter and programming menu.

### Case

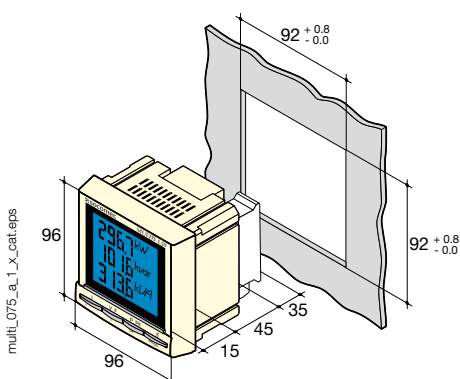

Type	panel mounting
Dimensions W x H x D	96 x 96 x 60 mm
Case degree of protection	IP30
Front degree of protection	IP52
Display type	backlit LCD display
Terminal block type	fixed or plug-in
Voltage and other connection cross-section	0.2 ... 2.5 mm <sup>2</sup>
Current connection cross-section	0.5 ... 6 mm <sup>2</sup>
Weight	400 g

### Plug-in modules

#### MULTIS L50



#### 1 Output

1 output assignable to:

- Pulses: configurable (type, weight, duration) in kWh or kvarh.
- Remote command of device.



#### Communication

RS485 link with JBUS / MODBUS protocol (speed up to 38400 bauds)



#### 3 inputs, 1 output

3 inputs assignable to:

- Remote status device.

1 output assignable to:

- Pulses: configurable (type, weight, duration) in kWh or kvarh.
- Remote command of device.

### Accessories

#### Current transformers (contact us)



#### IP65 protection



#### Panel mounting kit for a 144 x 96 mm cut-out



# MULTIS L50

Digital panel meter

three phases - via CT up to 6000 A dimensions 96 x 96 mm

## Electrical characteristics

Current measurement (TRMS)	
Via CT primary	9 999 A
Via CT secondary	5 A
Measurement range	0 ... 11 kA
Input consumption	0.6 VA
Measurement updating period	1 s
Accuracy	1%
Permanent overload	6 A
Intermittent overload	10 I <sub>n</sub> for 1 s
Voltage measurements (TRMS)	
Direct measurement between phases	50 ... 500 VAC
Direct measurement between phase and neutral	28 ... 289 VAC
Input consumption	≤ 0.1 VA
Measurement updating period	1 s
Accuracy	1%
Permanent overload	800 VAC
Power measurement	
Measurement updating period	1 s
Accuracy	1%
Power factor measurement	
Measurement updating period	1 s
Accuracy	1%
Frequency measurement	
Measurement range	45 ... 65 Hz
Measurement updating period	1 s
Accuracy	0.1 %

Energy accuracy	
Active (according to IEC 62053-21)	Class 1
Reactive (according to IEC 62053-23)	Class 2
Auxiliary power supply	
Alternating voltage	110 ... 250 VAC
AC tolerance	± 10 %
Direct voltage	120 ... 250 VDC
DC tolerance	± 10%
Frequency	50 / 60 Hz
Consumption	10 VA
Pulse or alarm output	
Number	1
Type	100 VDC - 0.5 A - 10 VA
Max. number of operations	≤ 10 <sup>8</sup>
Inputs	
Number	3
Power supply	10 ... 30 VDC
Minimum signal width	10 ms
Minimum duration between 2 pulses	18 ms
Type	Phototransistors
Communication	
Link	RS485
Type	2 ... 3 half duplex wires
Protocol	MODBUS RTU
MODBUS® speed	1400 ... 38400 bauds
Operating conditions	
Operating temperature	- 10 ... + 55 °C
Storage temperature	- 20 ... + 85 °C
Relative humidity	95 %

## Terminals

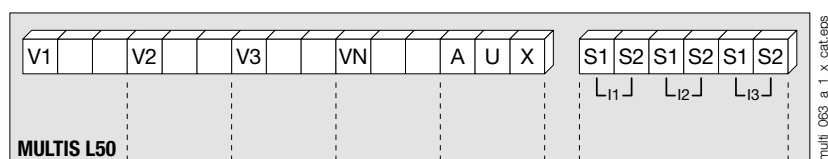

S1 - S2: current inputs.

AUX: auxiliary power supply U<sub>s</sub>.  
V1, V2, V3 & VN: voltage inputs.

### Communication module

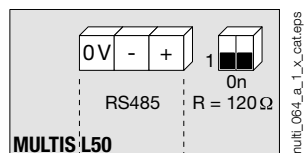

RS485 link.  
R = 120 Ω: selectable internal resistance for RS485 end of line termination.

### Output or alarm module

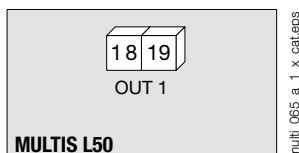

18 - 19: output n°1

### 3 inputs, 1 output module

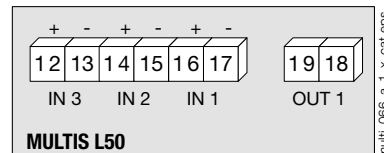

## Connection

### Recommendation:

- For IT earthing systems, it is recommended that the CT secondary is not connected to earth.
- When disconnecting the DIRIS, the secondary of each current transformer must be short-circuited. This operation can be carried out automatically by a SOCOMEC PTI, an accessory which is included in this catalogue. Please consult us.

### Low voltage balanced network

#### 3/4 wires with 1 CT

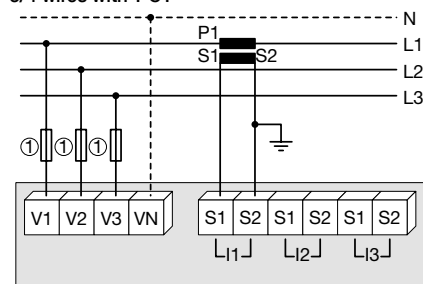

Use of 1 CT reduces by 0.5% the accuracy of the phases, the current of which is worked out by vector calculation.  
1. Fuses 0.5 A gG / 0.5 A class CC.

#### Single-phase

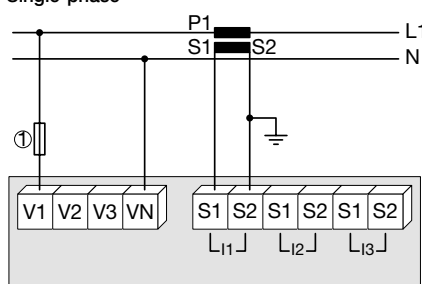

1. Fuses 0.5 A gG / 0.5 A class CC.

#### Two-phase

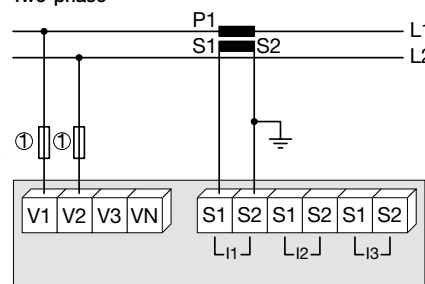

1. Fuses 0.5 A gG / 0.5 A class CC.

#### Low voltage unbalanced network

##### 3/4 wires with 3 CTs

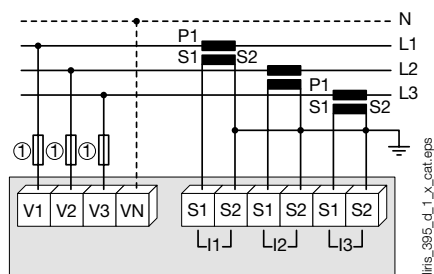

1. Fuses 0.5 A gG / 0.5 A class CC.

##### 3 wires with 2 CTs

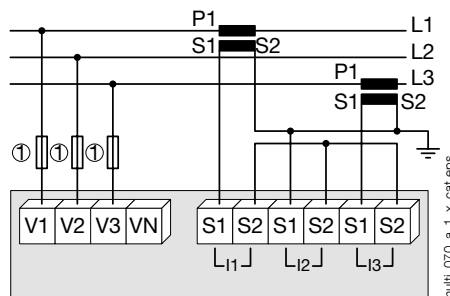

Use of 2 CTs reduces by 0.5% the accuracy of the phases, the current of which is worked out by vector calculation.

1. Fuses 0.5 A gG / 0.5 A class CC.

##### 3 wires with 2 CTs

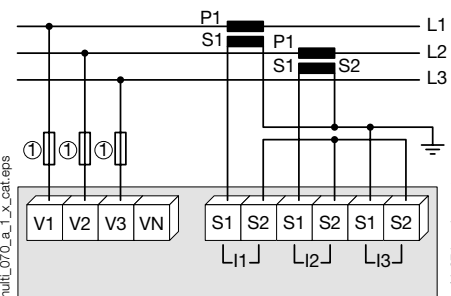

Use of 2 CTs reduces by 0.5% the accuracy of the phases, the current of which is worked out by vector calculation.

1. Fuses 0.5 A gG / 0.5 A class CC.

#### Additional information

##### Communication via RS485 link

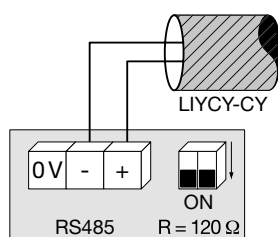

##### AC & DC auxiliary power supply

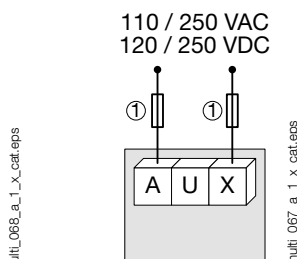

1. Fuses 0.5 A gG / 0.5 A class CC.

#### References

Basic device		MULTIS L50
MULTIS L50		Reference 192J 9120
Optional plug-in modules		Reference
1 output		4825 0080
RS485 MODBUS® communication		4825 0082
3 inputs, 1 output		4825 0083
Accessories		
Description of accessories	To be ordered in multiples of	Reference
IP65 protection	1	4825 0089
Panel mounting kit for a 144 x 96 mm cut-out	1	4825 0088
Fuse holder for the protection of voltage inputs (type RM) 3 poles	4	5601 0018
Fuse holder for the protection of the auxiliary supply (type RM) 1 pole + neutral	6	5601 0017
Fuse type gG 10x38 0.5 A	10	6012 0000
Ferrite to be associated with communication modules	1	4899 0011
Current transformer range	1	Contact us

#### Expert Services

- > Study, definition, advice, implementation, maintenance and training... Our experts "Expert Services" offer complete support for the success of your project.







# Socomec worldwide

## IN INDIA

### CORPORATE OFFICE

B1, II Floor  
Thiru-Vi-Ka Industrial Estate  
Guindy, Chennai - 600 032  
Tel: +91 44 3921 5400 / 5423 / 5466  
Mob: +91 9711229993, +91 9790968731  
Fax: +91 44 39215450  
info.in@socomec.com

### MANUFACTURING FACILITY

756 Pace City II  
Sector 37  
Gurgaon - 122 001  
Haryana  
Tel: +91 124 4562700, 4597803  
Fax: +91 124 4562733  
CIN: U00000HR1999PTC038504

### BRANCH OFFICES

#### BANGALORE

160, Arun Arch, 2<sup>nd</sup> Floor  
9<sup>th</sup> Cross, Indiranagar First Stage  
Bangalore - 560 038  
Tel: +91 80 41739101-03  
Mob: +91 9972578171, +91 9886323448

#### COCHIN

47/590, Mattathumkattil  
Narayanan Asan Road  
Ponnurruni, Vyttila  
Cochin - 682019  
Mob: +91 9745012322, +91 8939550688

#### COIMBATORE

12, 3<sup>rd</sup> Cross Street  
Lakshimpuram, Ganapathy  
Coimbatore - 641 006  
Mob: +91 8939550688, +91 9003032012

#### HYDERABAD

3<sup>rd</sup> Floor  
6-3-652/K/12, KAUTILYA Complex  
Somajiguda  
Hyderabad - 500 082  
Mob: +91 9959444277, +91 9642528800

#### KOLKATA

AK-257, Sector-2  
Salt Lake City, Kolkata - 700091  
Mob: +91 9836405558, +91 8697709095

#### MUMBAI

Office No.404, 4<sup>th</sup> Floor  
"C" Wing, Neelkanth Business Park  
Nr. Vidyavihar Station, Vidyavihar (W)  
Mumbai - 400 086  
Tel: +91 9987052602, +91 9167542007

#### NEW DELHI

Plot No 100, 1<sup>st</sup> Floor  
Okhla Industrial Estate Phase III  
New Delhi - 110020  
Tel: +91 11 40884000  
Mob: +91 9958595941, +91 9953595413

#### PUNE

Plot No. 30, Wireless  
Co-operative Society  
Behind Convergys, Aundh  
Pune 411 007  
Telefax: +91 20 25881587  
Mob: +91 9987052604, +91 9423204106

### RESIDENT OFFICES

#### AHMEDABAD

+91 9727753931  
+91 9376639333

#### CHANDIGARH

+91 9023154784

#### TRIVANDRUM

+91 9020179364

#### VADODARA

+91 9099947988

## IN EUROPE

### BELGIUM

### FRANCE

### GERMANY

### ITALY

### NETHERLANDS

### POLAND

### PORTUGAL

### ROMANIA

### SLOVENIA

### SPAIN

### SWITZERLAND

### UNITED KINGDOM

### TURKEY

## IN ASIA PACIFIC

### AUSTRALIA

### CHINA

### SINGAPORE

### THAILAND

## IN MIDDLE EAST

### UNITED ARAB EMIRATES

## IN AMERICA

### USA, CANADA & MEXICO

## OTHER COUNTRIES

[www.socomec.co.in/worldwide](http://www.socomec.co.in/worldwide)

## HEAD OFFICE

### SOCOMECS GROUP

SAS SOCOMECS capital 10 688 000 €  
R.C.S. Strasbourg B 548 500 149  
B.P. 60010 - 1, rue de Westhouse  
F-67235 Benfeld Cedex - FRANCE  
Tel. +33 3 88 57 41 41  
Fax +33 3 88 74 08 00  
info.scp.isd@socomec.com

## YOUR DISTRIBUTOR / PARTNER

[www.socomec.co.in](http://www.socomec.co.in)

your energy  
our expertise



**socomec**  
Innovative Power Solutions