

# Monitor Heater Condition with the K7TM



# To reduce unexpected downtime and wasteful costs due to heater burnout

Heater equipment that operates at high temperatures is more likely to experience unplanned downtime due to heater burnout. Preventing burnout requires the heater's condition to be monitored, which was previously a time consuming and costly task, which can now be automated with the K7TM.

## Issues concerning heater burnout

Downtime resulting from heater replacement and warm up is time consuming



As the heater burns out, production fallout will impact overall efficiency and profitability



Planned maintenance costs associated with heaters are currently a manual and labor intensive process

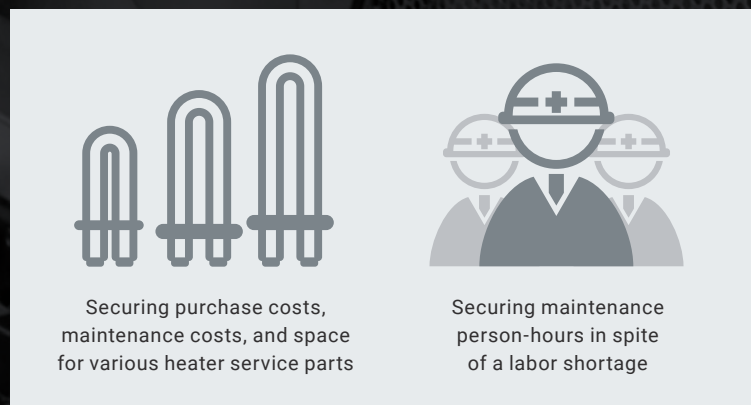

# From planned and unplanned maintenance to predictive maintenance using condition monitoring

The K7TM Heater Condition Monitoring device can measure the resistance values of resistive heaters Properly and regardless of controller methods and heater temperature characteristics allowing for heater condition monitoring. This enables heater equipment condition to be monitored over time and notify of abnormalities and burnout.

The H7TM adds value by offering....

Appropriate heater conditioning monitoring, independent from temperature control method, heater temperature characteristics, and location

> P.4

Predictive maintenance that quantifies the deterioration state of the heater

> P.6



# Appropriate heater conditioning monitoring ,independent from temperature control method, heater temperature characteristics, and location

The K7TM Heater Condition Monitoring device can measure the resistance values of resistive heaters properly and periodically allowing for heater condition and trend monitoring both on site and remotely.

## Eliminating heater burnout reduces unplanned downtime, profit loss from yield issues and replacement part costs

Heater resistance value trends are not able to be determined using the basic voltage/current calculation since the temperature controller and heater characteristics influence this calculation. The K7TM is able to measure the resistance values regardless of these influences by filtering them out of this calculation. Additionally, the K7TM is able to monitor the deterioration trends in heater resistance by comparison with historical resistance values when used in the same environment.

### Heater temperature characteristics

Depending on the type of heater, the resistance value may vary greatly depending on the temperature. Heater temperature characteristics need to be considered in order to monitor proper heater deterioration trends. Therefore, it is necessary to constantly monitor the heater resistance value at the same timing as the heater temperature.

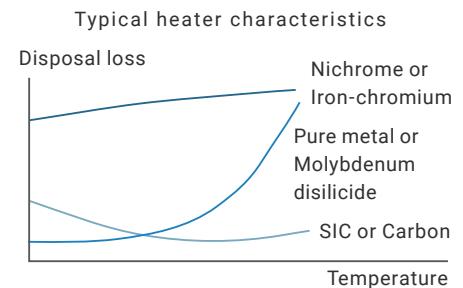

### Measurement method in K7TM

Resistance values obtained by Voltage ÷ Current  
(Heater whose resistance decreases as the temperature rises)

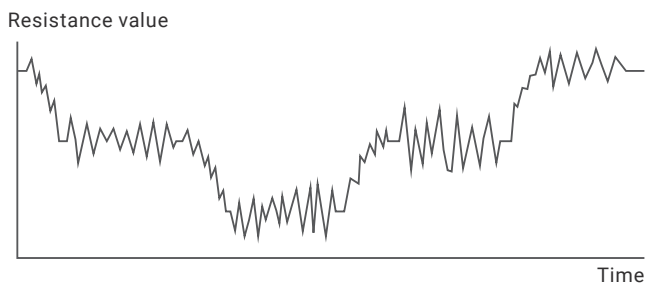

Resistance value changes after the influence of temperature control was removed by filtering

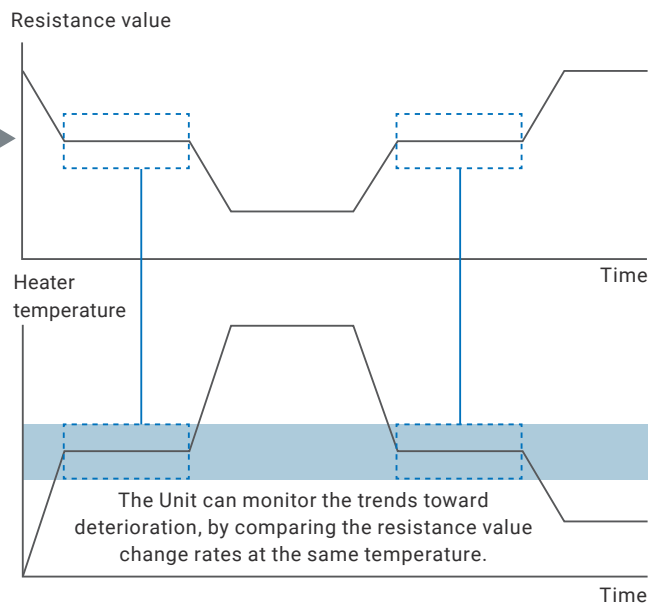

K7TM calculates the rate of change of the resistance value (reference resistance value change rate) from the resistance value (reference resistance value) when replacing the heater and the current heater resistance value, and utilizes it as an indicator to measure the degradation trend.

### Changes in heater temperature and resistance (Long Term)

Since the temperature is controlled, the temperature of the heater is constant, but the resistance of the heater increases with deterioration.

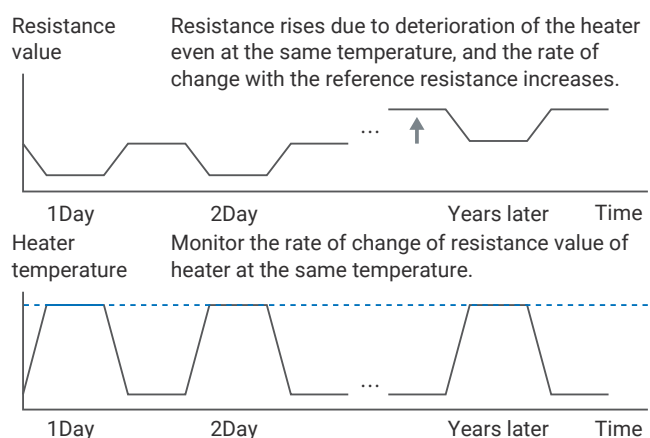

## Collecting measurement data remotely using network connections

The K7TM allows you to monitor condition both on site and remote without requiring on site visits.

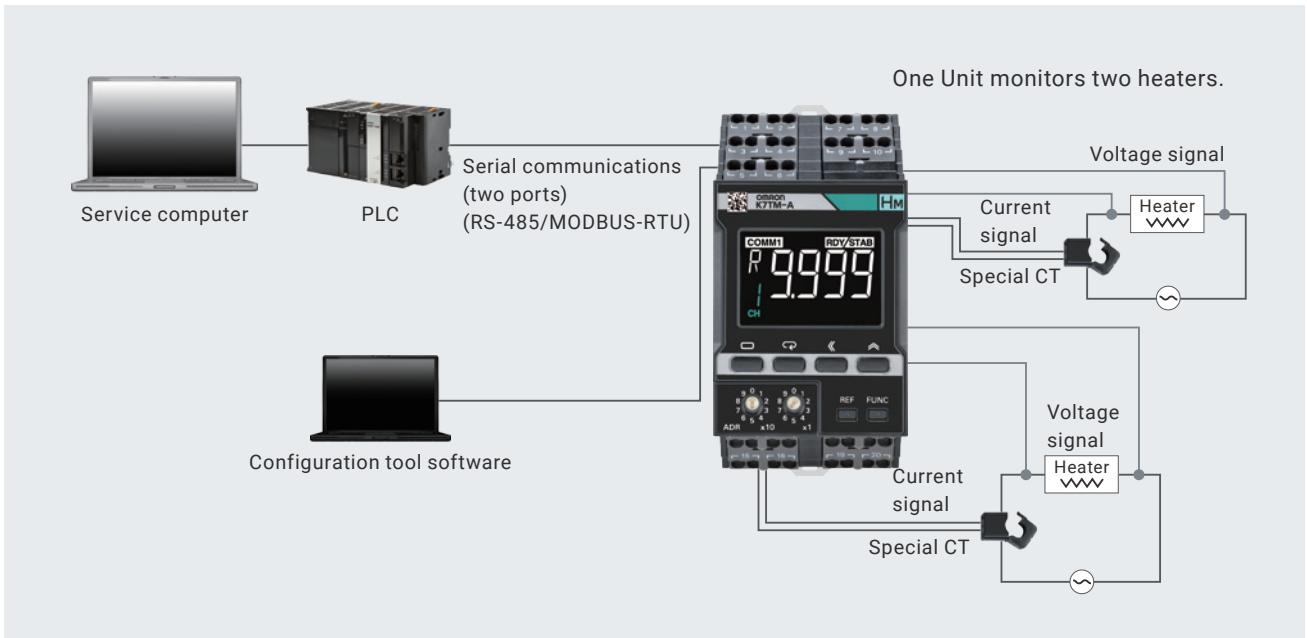

## Easy to retrofit onto existing equipment

Condition monitoring can be achieved by using a CT clamp on the power line of the heater and connecting voltage lines to each side of the heater.

### Special CT K6CM-CICB



Example case where a special CT is attached to the cable

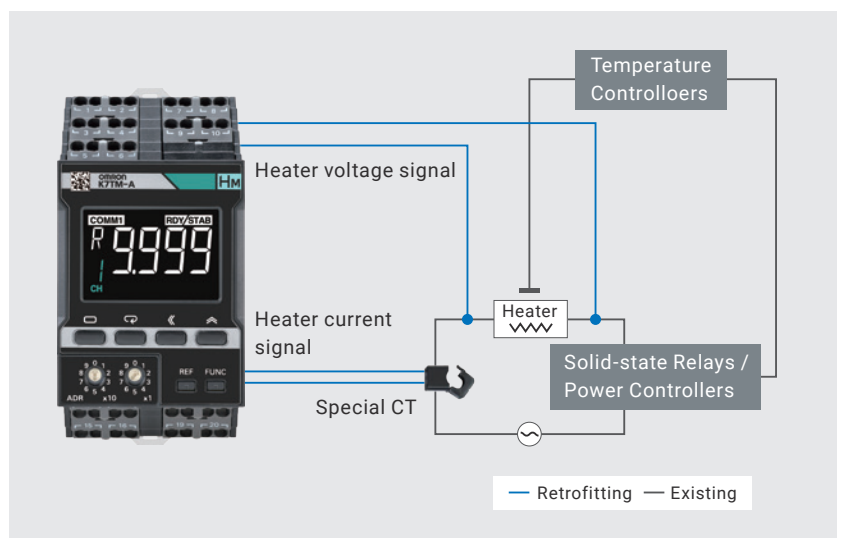

# Predictive maintenance that quantifies the deterioration state of the heater

By converting condition of the heater into a numerical value called the rate of change of the heater resistance value, scheduled maintenance based on the numerical value becomes possible. It also enables maintenance of heater equipment that does not depend on skilled personnel.

## Ready to perform maintenance based on the degree of deterioration from heater resistance values

The K7TM can monitor the state of the heater by the rate of change of the heater resistance value and monitor the state and tendency of each heater, so it is possible to determine when replacement is necessary, so it is unplanned while utilizing the remaining life of the heater. You can reduce the possibility of downtime. In addition, maintenance that does not depend on skilled people becomes possible.

Example of monitoring heaters in a kiln

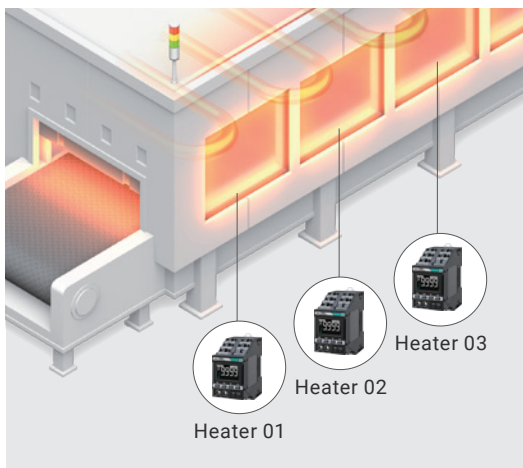

Heater resistance value change rate  
(Reference resistance value change rate)

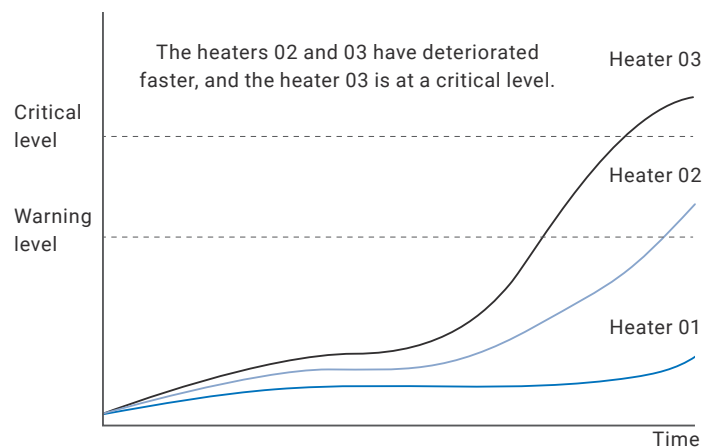

## Using reference Resistance Value Change Rate to determine replacement.

Previously there were challenges in determining correct service and replacement time on heater equipment. Since the K7TM can capture deterioration trends in heater resistance values change rate and trigger alarms when a threshold is reached, the user is able to determine the optimal time to service or replace heater equipment.

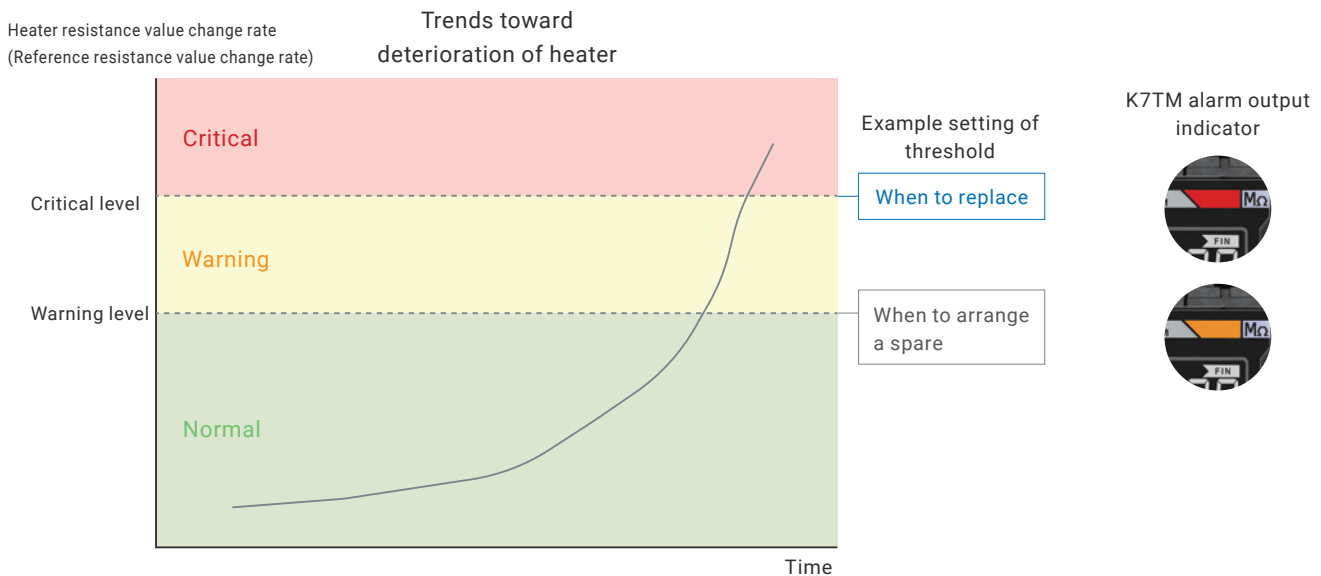

Note 1. The K7TM captures the heater deterioration due to oxidization by monitoring changes in the heater resistance value. The Unit cannot capture the deterioration due to other factors.

Note 2. Set an appropriate threshold that suits your environment as the trends toward deterioration of heater may vary depending on the heater type and the use environment.

# Introducing Predictive Maintenance Solutions

## Three Values of Omron's Condition Monitoring



Replicate maintenance  
engineer's analysis



Retrofit



Simple remote  
monitoring

### Resolve issues through condition monitoring

Our predictive maintenance solution is based on replicating skilled maintenance engineer's analysis, retrofitting existing equipment and remote monitoring. The technology simplifies the analysis of equipment by translating measurement data into simple alarms so a maintenance engineer can respond faster to issues.

**Note: Do not use this document to operate the Unit.**

**OMRON Corporation Industrial Automation Company**  
Kyoto, JAPAN

**Contact: [www.ia.omron.com](http://www.ia.omron.com)**

**Regional Headquarters**

**OMRON EUROPE B.V.**

Wegalaan 67-69, 2132 JD Hoofddorp  
The Netherlands  
Tel: (31)2356-81-300/Fax: (31)2356-81-388

**OMRON ELECTRONICS LLC**

2895 Greenspoint Parkway, Suite 200  
Hoffman Estates, IL 60169 U.S.A.  
Tel: (1) 847-843-7900/Fax: (1) 847-843-7787

**OMRON ASIA PACIFIC PTE. LTD.**

No. 438A Alexandra Road # 05-05/08 (Lobby 2),  
Alexandra Technopark,  
Singapore 119967  
Tel: (65) 6835-3011/Fax: (65) 6835-2711

**OMRON (CHINA) CO., LTD.**

Room 2211, Bank of China Tower,  
200 Yin Cheng Zhong Road,  
PuDong New Area, Shanghai, 200120, China  
Tel: (86) 21-5037-2222/Fax: (86) 21-5037-2200

**Authorized Distributor:**

© OMRON Corporation 2022 All Rights Reserved.  
In the interest of product improvement,  
specifications are subject to change without notice.

**CSM\_1\_1**

**Cat. No. N229-E1-01**

0122 (0122)