

# Wiring system interface with Push-In Plus technology

XW6T

Wiring indicator for confirmation of correct operation

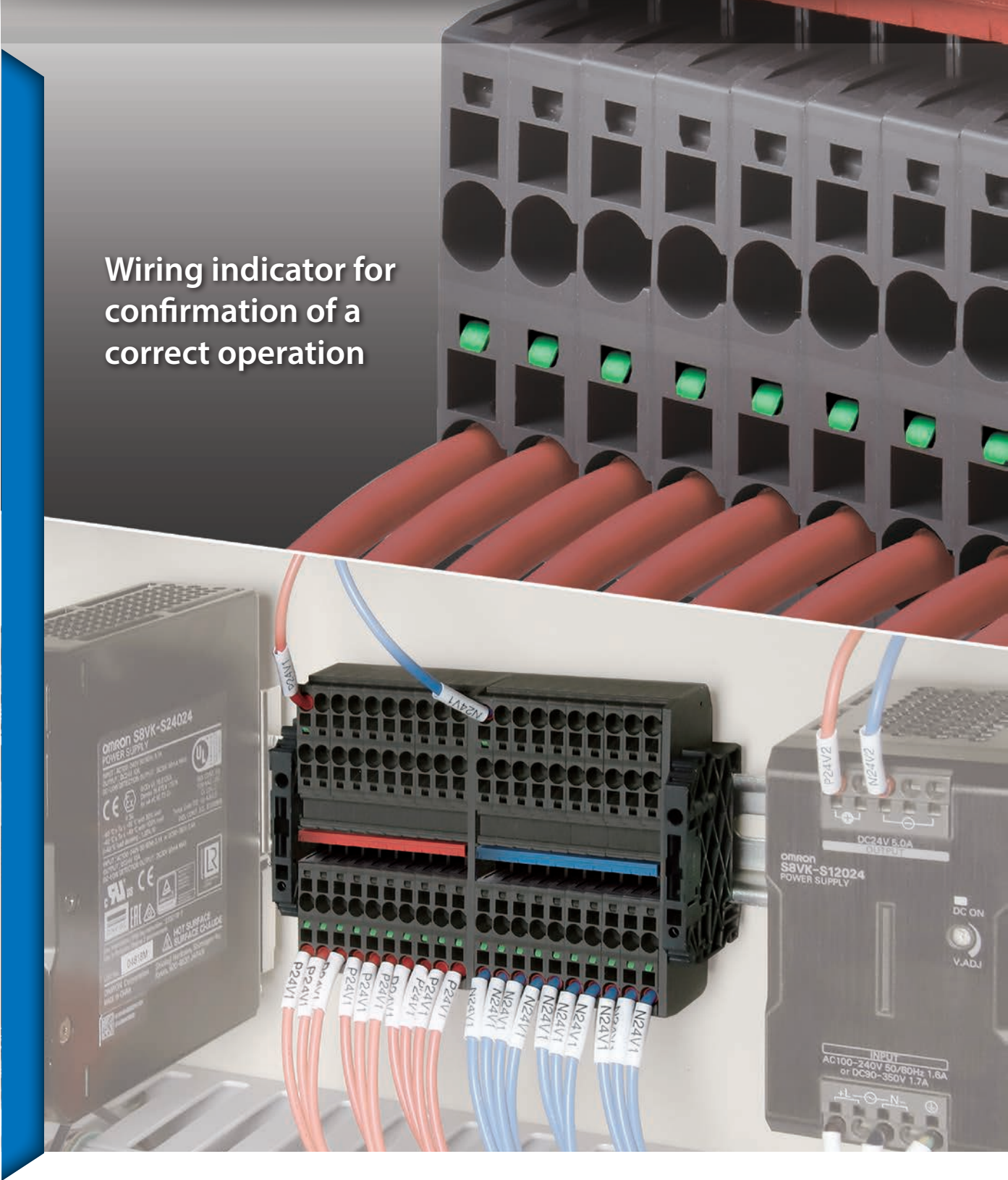

# Wiring Completion is Simply Visible

## Production

### Wiring indicator for confirmation of a correct operation.

A green indicator comes out when a cable is insert deeply into the terminal hole giving immediate confirmation of the proper wiring insertion. Enabling secure wiring.

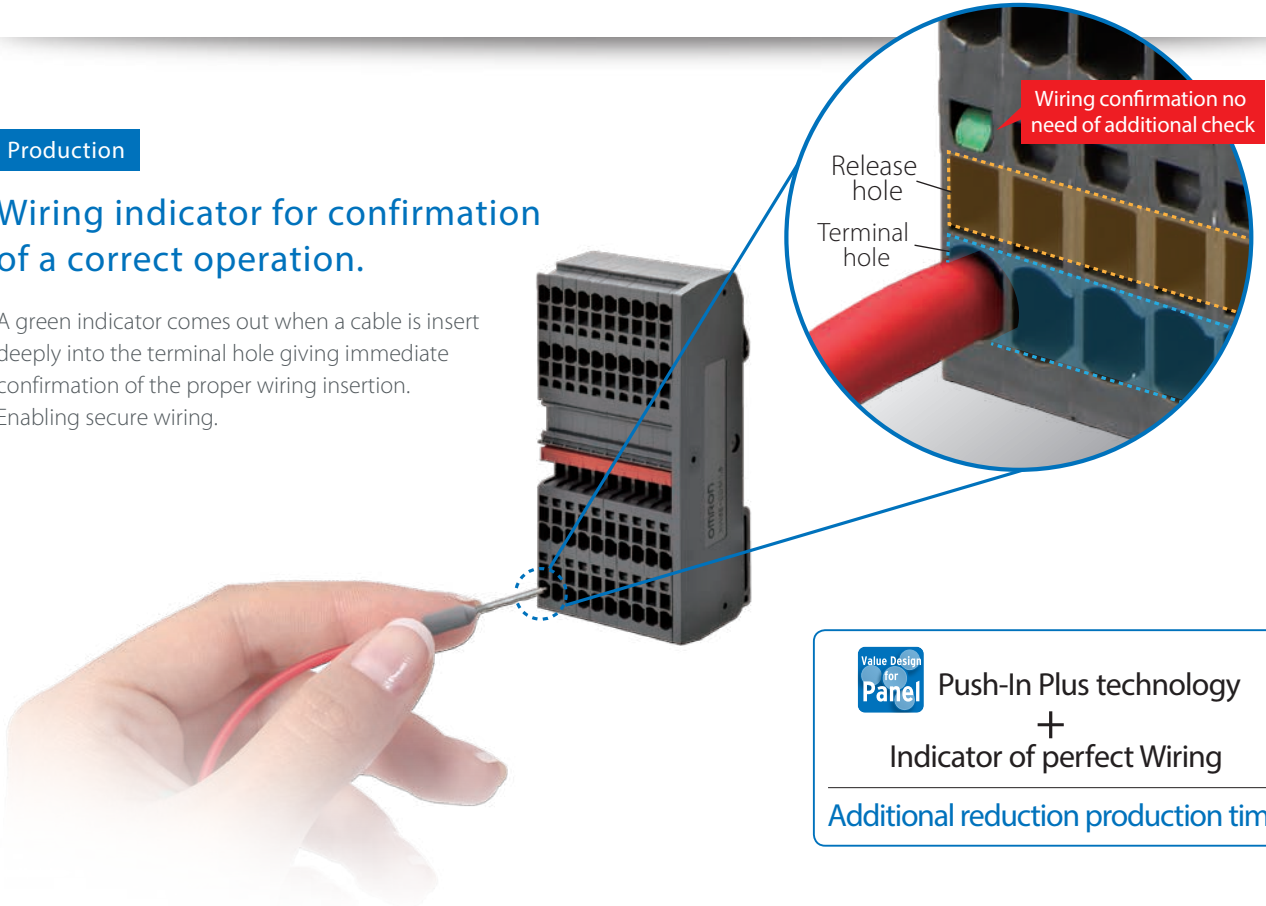

### No Troublesome Crossover Wiring Required. Easy Recognition of the Common Area.\*

Colored Short Bars are built in. You can easily know the common area thanks to the visible Short Bars placed at the front face of the Terminal Blocks.

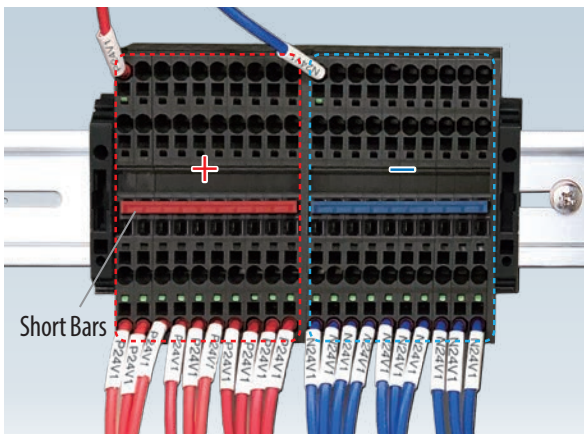

### Quick Inspection and Installation.

You can immediately judge the wiring state thanks to the visible indicators avoiding errors, such as non-wiring and incomplete wiring.

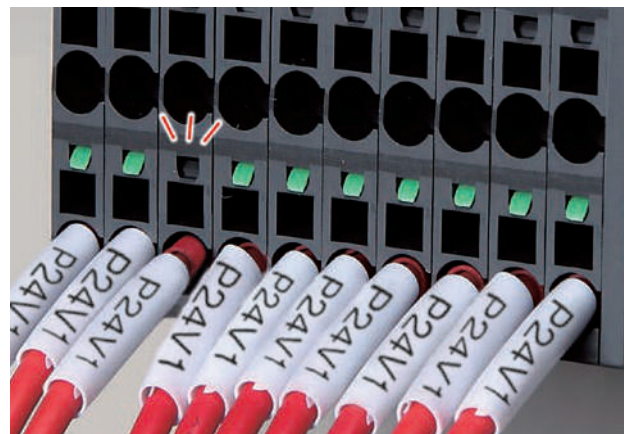

\* With common area is intended the area where they are electrically connected.

## Maintenance

You can judge the wiring state  
Just looking at the indicators.  
No Retightening is Required...

Simply check the indicators for wiring  
maintenance.  
No retightening is required,  
the terminals are firmly hold in place  
thanks to Push-In Plus technology.

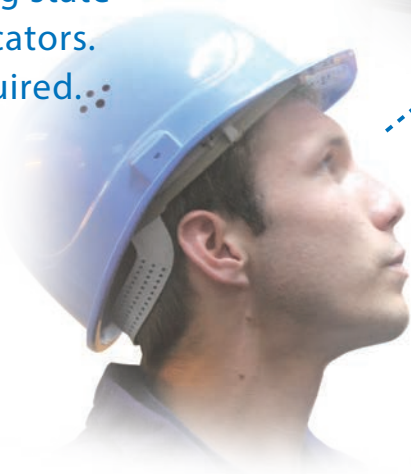

Push-In Plus technology the best  
solution against vibrations.

# Help to Downsize Control Panel and Reduce Design Time.

## Design

The Best-in-Class Slim Models  
Available to Help Downsize  
Control Panels.

### Example of 40 pins

Model with Screw Terminal Blocks 7 mm pitch 40 pins (20P)

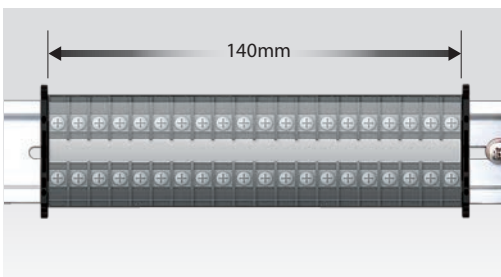

WX6T 3.5 mm pitch 40 pins

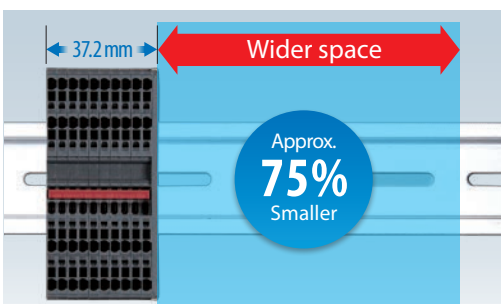

No Need to Select Accessories  
for Making Common Part.

Necessary Items for a Wiring System Interface Are Contained in a Set.

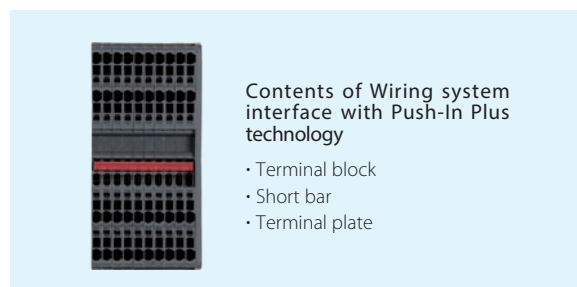
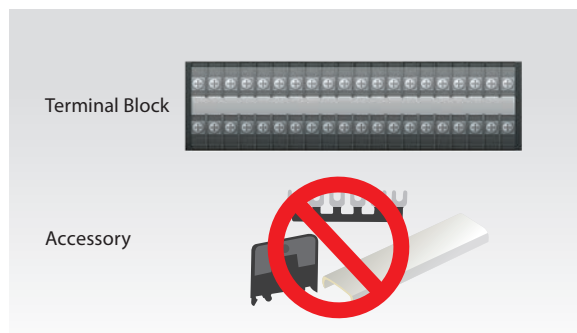

Note: The picture shows XW6T-COM1.5X40RD.  
\* For details, refer to Ordering Information on page 6.



# Push-In Plus technology for Easy Wiring

Now you can use Push-In Plus technology to reduce wiring time and work: Just insert wires, no tools required.

## Easy to Insert

OMRON's Push-In Plus technology are as easy as inserting to an earphone jack. They help reduce the work load and improve wiring quality.

## Held Firmly in Place

Even though less insertion force is required, the wires are held firmly in place. The advanced mechanism and the manufacturing technology produce a spring that ensures better workability and reliability. The same strength as screw terminal blocks is provided.

## Greatly Reduce Wiring Work with Push-In Plus technology

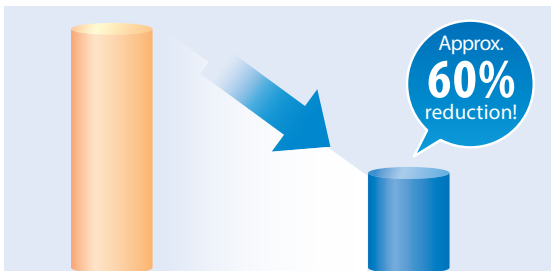

Conventional screw terminal blocks    OMRON Push-In Plus terminal block

\*Information for Push-In Plus and screw terminal blocks is based on OMRON's actual measurement value data.



## No Retightening Required

If you use Push-In Plus technology you don't need to tighten screws, necessary for screw TB.



## Wiring Possible with Stranded Wires

You can insert wires with ferrules or you can also insert solid wires or stranded wires.



## Work with Both Hands

Thanks to the holding mechanism of the screw you can easily wire stranded cables using both hands.

## Resolving Your Questions and Concerns When You First Introduce the Push-In Plus Terminal Blocks

For details, refer to the Innovation in Control Panel Building (Cat. No. Y230).

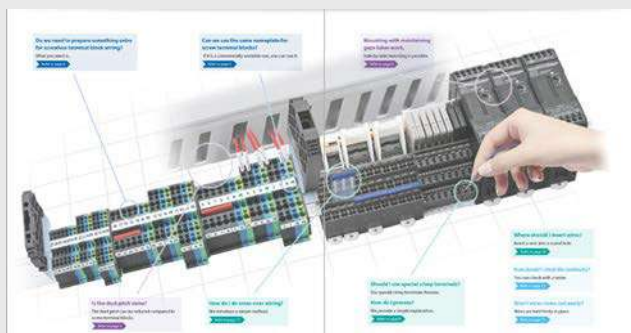

# XW6T

## Downsize Control Panels and Save Work with Common Terminal Blocks with Visible Indicators

- Indicators make wiring completion simply visible. Proper wiring without skillful operators.
- Simply check the indicators for wiring maintenance, helping reduce maintenance works.
- Short Bars enable pre-connected common wiring. No troublesome crossover wiring required.
- The best-in-class slim models available to help downsize control panels.
- Wiring system interface with Push-In Plus technology enables no loosening of wiring, providing a maintenance-free operation.



For the most recent information on models that have been certified for safety standards, refer to your OMRON website.

Refer to *Safety Precautions* on page 11.

## Model Number Legend

### Model Reference

Use this legend when determining the product specifications from the model number. Select models from **Ordering Information** for orders.

**XW6T - COM**    **X**         

(1)           (2) (3)

**(1) Maximum Applicable Stranded Wire**  
 1.5: 1.5 mm<sup>2</sup>  
 2.5: 2.5 mm<sup>2</sup>

**(2) Number of Pins**  
 8: 8 pins  
 12: 12 pins  
 16: 16 pins  
 20: 20 pins  
 40: 40 pins

**(3) Color of Short Bars**  
 RD: Red  
 BL: Blue  
 YL: Yellow

## Part Names and Configuration

### Terminal Block

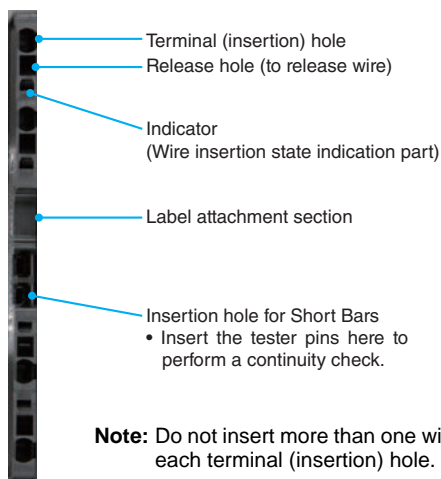

### Basic Configuration

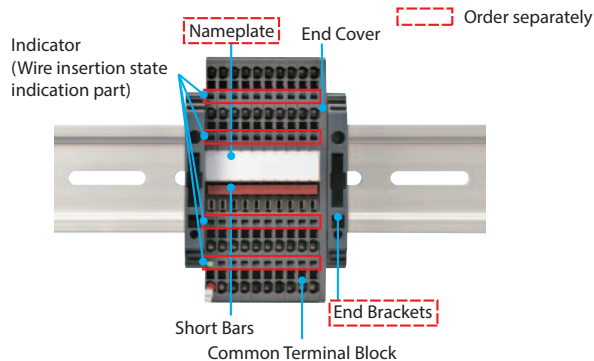











Name	Description
Common Terminal Block	Five types of 8/12/16/20/40 pins are available.
End Cover	This part is required to prevent electrical shock. Attached on the end surface (metal exposure part) of the last terminal block.
End Brackets	This part is available as an accessory. End blocks must be attached on the both ends to hold terminal block in place.
Nameplate	This part is available as an accessory. Select the most suitable one for your needs. You can also use commercially available nameplates that are 9.5 mm wide and 0.5 mm thick.
Short Bars	All pins are shorted.
Indicator	Turns in green when the connection is completed.

# XW6T

## Ordering Information

### Model

Appearance and internal wiring	Maximum Conductor Cross Section Fine Stranded (mm <sup>2</sup> )	Number of pins	Color of Short Bars	Weight (g)	Model
	1.5	8	Red	Approx. 16	XW6T-COM1.5X8RD
			Blue		XW6T-COM1.5X8BL
			Yellow		XW6T-COM1.5X8YL
		12	Red	Approx. 23	XW6T-COM1.5X12RD
			Blue		XW6T-COM1.5X12BL
			Yellow		XW6T-COM1.5X12YL
		16	Red	Approx. 29	XW6T-COM1.5X16RD
			Blue		XW6T-COM1.5X16BL
			Yellow		XW6T-COM1.5X16YL
		20	Red	Approx. 36	XW6T-COM1.5X20RD
			Blue		XW6T-COM1.5X20BL
			Yellow		XW6T-COM1.5X20YL
	40	Red	Approx. 68	XW6T-COM1.5X40RD	
		Blue		XW6T-COM1.5X40BL	
		Yellow		XW6T-COM1.5X40YL	
	2.5	8	Red	Approx. 28	XW6T-COM2.5X8RD
			Blue		XW6T-COM2.5X8BL
			Yellow		XW6T-COM2.5X8YL
		12	Red	Approx. 41	XW6T-COM2.5X12RD
			Blue		XW6T-COM2.5X12BL
			Yellow		XW6T-COM2.5X12YL
		16	Red	Approx. 53	XW6T-COM2.5X16RD
			Blue		XW6T-COM2.5X16BL
			Yellow		XW6T-COM2.5X16YL
		20	Red	Approx. 65	XW6T-COM2.5X20RD
			Blue		XW6T-COM2.5X20BL
			Yellow		XW6T-COM2.5X20YL
	40	Red	Approx. 126	XW6T-COM2.5X40RD	
		Blue		XW6T-COM2.5X40BL	
		Yellow		XW6T-COM2.5X40YL	

**Note:** Products will be delivered in the form of common terminal blocks (with terminal blocks, a short bar, and an end cover) as shown in the appearance.

(Example) XW6T-COM1.5X8RD set contents  
 Terminal block unit (4 terminals) × 2  
 Short bar (two-poles, red) × 1  
 End cover × 1

## Accessories (Order separately)

### Terminal Block Unit (For addition)

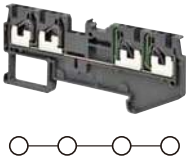
Appearance and internal wiring	Applicable Terminal Blocks	Model	Application
	XW6T-COM1.5X□□□□	<b>XW6T-COM1.5</b>	This is a Terminal Block for addition. By using it with Short Bars as a set, Addition of the common points is available. Always attach the end cover after addition to prevent electrical shock. (Refer to page 14 for details.)
	XW6T-COM2.5X□□□□	<b>XW6T-COM2.5</b>	

### Short Bars

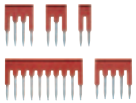
Appearance	Applicable Terminal Blocks	Number of poles	Covering color	Model*	Application
	XW6T-COM1.5X□□□□	2	Red (RD) Blue (BL) Yellow (YL)	<b>XW5S-P1.5-2</b> □	Used for crossover wiring between Terminal Blocks.
		3		<b>XW5S-P1.5-3</b> □	
		4		<b>XW5S-P1.5-4</b> □	
		5		<b>XW5S-P1.5-5</b> □	
		10		<b>XW5S-P1.5-10</b> □	
	XW6T-COM2.5X□□□□	2	Red (RD) Blue (BL) Yellow (YL)	<b>XW5S-P2.5-2</b> □	
		3		<b>XW5S-P2.5-3</b> □	
		4		<b>XW5S-P2.5-4</b> □	
		5		<b>XW5S-P2.5-5</b> □	
		10		<b>XW5S-P2.5-10</b> □	

\* Replace the box (□) in the model number with the code for the covering color. Selection of the box (□): RD=Red, BL=Blue, YL=Yellow

### End Cover

Appearance	Applicable Terminal Blocks	Model	Application
	XW6T-COM1.5X□□□□	<b>XW6E-COM1.5</b>	This part is required to prevent electrical shock. Attach end covers for the Terminal Blocks before use on the following parts. (Refer to page 14 for details.) <ul style="list-style-type: none"> <li>Exposed metal surface of the last Terminal Block</li> <li>Any Terminal Block that is next to a different shape of Terminal Blocks.</li> </ul>
	XW6T-COM2.5X□□□□	<b>XW6E-COM2.5</b>	

### End Brackets



Appearance	Width (mm)	Model	Application
	6	<b>XW5Z-EP6</b>	End Brackets are installed on the both ends of the Terminal Blocks to prevent them from moving on DIN Track.

**Note:** Short bars and end covers come attached to the common terminal blocks. Please select when necessary for expansion applications.

# XW6T

## Ratings and Performance

### Ratings

Model		XW6T-COM1.5X□□□□				XW6T-COM2.5X□□□□			
Appearance									
Applicable wire sizes *1	Standard wire	0.08 mm <sup>2</sup> to 1.5 mm <sup>2</sup>				0.14 mm <sup>2</sup> to 2.5 mm <sup>2</sup>			
	Solid wire	0.14 mm <sup>2</sup> to 1.5 mm <sup>2</sup>				0.14 mm <sup>2</sup> to 4.0 mm <sup>2</sup>			
	Stranded wire with ferrule with Plastic sleeve	0.14 mm <sup>2</sup> to 0.75 mm <sup>2</sup> (1.5 mm <sup>2</sup> ) *2				0.14 mm <sup>2</sup> to 2.5 mm <sup>2</sup>			
Dimensions		A × 78 × 31.3 (Dimension A...8 pins: 9.2, 12 pins: 12.7, 16 pins: 16.2, 20 pins: 19.7, 40 pins: 37.2)				A × 82.6 × 36.1 (Dimension A...8 pins: 12.6, 12 pins: 17.8, 16 pins: 23.0, 20 pins: 28.2, 40 pins: 54.2)			
Rated voltage		500 V				800 V			
Rated current *3		17.5 A				24 A			
IEC rated voltage		500 V				800 V			
IEC rated current *3		17.5 A/1.5 mm <sup>2</sup>				24 A/2.5 mm <sup>2</sup>			
Usage Group (UG)		B, C		D		B, C			
UL rated voltage		300 V	51 to 150 V	151 to 300 V	301 to 600 V	600 V			
UL rated current *3		15 A/AWG14 (solid wires) 10 A/AWG16	15 A/AWG14 (solid wires) 10 A/AWG16	10 A/AWG16	5 A/AWG16-20	20 A/AWG12 (solid wire), 15 A/AWG14			
Withstand voltage		1,890 VAC for 1 min (leakage current: 1 mA max.)				2,000 VAC for 1 min (leakage current: 1 mA max.)			
End Cover		XW6E-COM1.5				XW6E-COM2.5			
Special tool		XW4Z-00B				XW4Z-00B			
Applicable nameplates		Commercially available nameplate with 9.5 mm width and 0.5 mm thickness				Commercially available nameplate with 9.5 mm width and 0.5 mm thickness			

\*1. For the recommended applicable wire ranges, refer to page 11 for solid and stranded wires and to page 13 for ferrules.

\*2. You can also use ferrules for 1.0 to 1.5 mm<sup>2</sup> wires if you use ferrules without insulation sleeve. Refer to page 13 for details.

\*3. Do not apply more than the rated current to the terminal block.

### Performance

Ambient temperature range	-40 to 55°C (with no condensation or icing)
Ambient humidity range	5 to 95%RH
Insulating material	PA resin
Fire resistance	UL94 V-0
Insertion durability	50 times
Vibration resistance	10 to 150 Hz, Acceleration of 50 m/s <sup>2</sup> for 80 min each in X, Y, and Z directions.
Shock resistance	500 m/s <sup>2</sup> for 11 ms each in 6 directions 5 times
Ambient storage temperature	-40 to 85°C (with no condensation or icing)
Ambient storage humidity	5 to 95%RH



**Standards**

**Compliant standard**

- UL1059
- CSA (C22.2 No.158)
- IEC 60947-7-1

**Certification**

- cURus (File No. E245101)

**Dimensions**

(Unit: mm)

**Model**

**XW6T-COM1.5X□□□□**

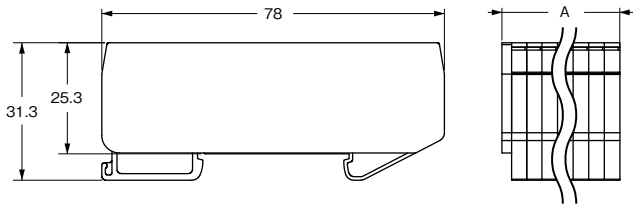

**Dimension A**

Model	Number of pins	Dimensions
XW6T-COM1.5X8□□	8 pins	9.2
XW6T-COM1.5X12□□	12 pins	12.7
XW6T-COM1.5X16□□	16 pins	16.2
XW6T-COM1.5X20□□	20 pins	19.7
XW6T-COM1.5X40□□	40 pins	37.2

**XW6T-COM2.5X□□□□**

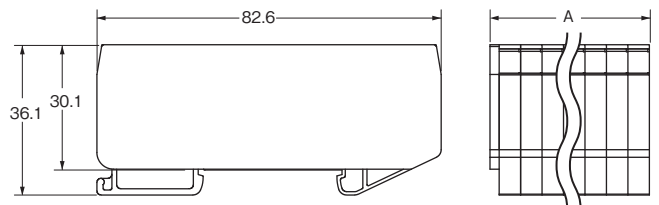

**Dimension A**

Model	Number of pins	Dimensions
XW6T-COM2.5X8□□	8 pins	12.6
XW6T-COM2.5X12□□	12 pins	17.8
XW6T-COM2.5X16□□	16 pins	23.0
XW6T-COM2.5X20□□	20 pins	28.2
XW6T-COM2.5X40□□	40 pins	54.2

**Accessories (Order separately)**

**(For addition) Terminal Block**

**XW6T-COM1.5**

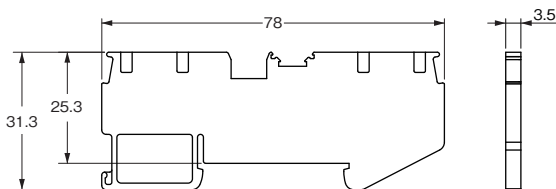

**XW6T-COM2.5**

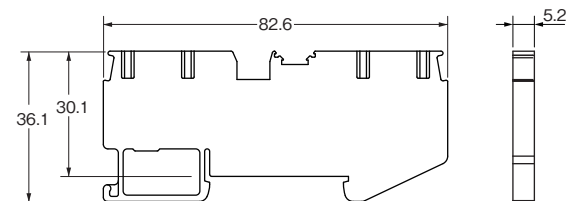

# XW6T

## Short Bars

### XW5S-P1.5-□

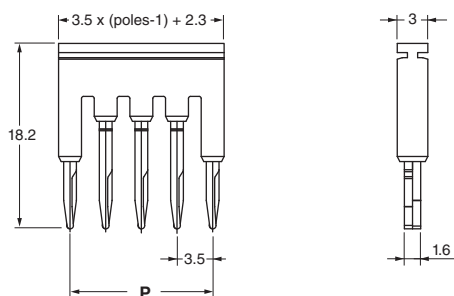

Model	P (mm)
XW5S-P1.5-2□	3.5
XW5S-P1.5-3□	7.0
XW5S-P1.5-4□	10.5
XW5S-P1.5-5□	14.0
XW5S-P1.5-10□	31.5

### XW5S-P2.5-□

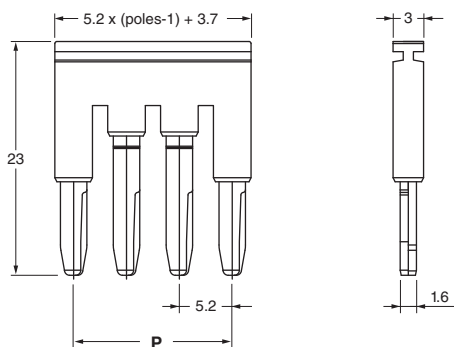

Model	P (mm)
XW5S-P2.5-2□	5.2
XW5S-P2.5-3□	10.4
XW5S-P2.5-4□	15.6
XW5S-P2.5-5□	20.8
XW5S-P2.5-10□	46.8

## End Cover

### XW6E-COM1.5

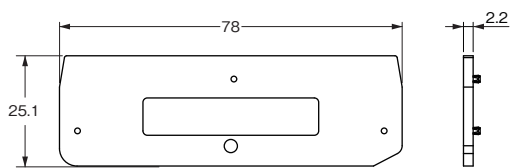

### XW6E-COM2.5

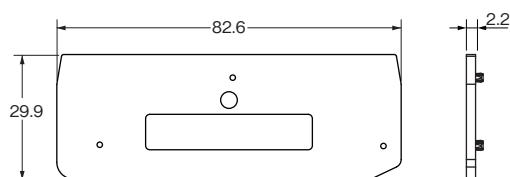

## End Brackets

### XW5Z-EP6

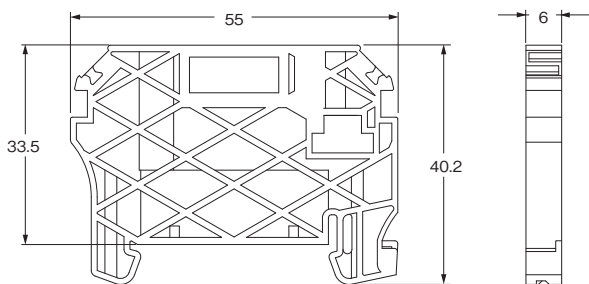

## Safety Precautions

### Warning Indications

<b>Precautions for Safe Use</b>	Supplementary comments on what to do or avoid doing, to use the product safely.
<b>Precautions for Correct Use</b>	Supplementary comments on what to do or avoid doing, to prevent failure to operate, malfunction, or undesirable effects on product performance.

### Precautions for Safe Use

- Do not drop the Terminal Block.  
Terminal Block functionality may be inhibited.
- Terminal Block is designed to satisfy the functions when mounting on the DIN Track. Always mount on the DIN Track.
- Do not exceeds the ratings. Doing so may result failure or burning.
- Mount the Terminal Block on a DIN Track and secure both ends with the Terminal Brackets.
- Do not use Terminal Blocks in locations where toxic gases, such as sulfide gas (H<sub>2</sub>S and SO<sub>2</sub>), ammonia gas (NH<sub>3</sub>), nitrogen gas (HNO<sub>3</sub>), chlorine gas (Cl<sub>2</sub>), or in locations subject to high temperature or humidity. Doing so may cause functional failure, such as damages due to contact failure or corrosion.
- Do not use the Terminal Blocks submersed in oil or water, or in locations continuously subject to splashes of oil or water. Doing so may result in oil or water entering and damaging the Terminal Blocks.
- Do not use or keep the Terminal Blocks under the following conditions:
  - Subject to severe temperature changes.
  - Subject to high humidity and condensation.
  - Subject to severe vibration or shock.
  - Where direct rays of the sun strike.
  - Where sea breeze may be present.
- When disposing, dispose the Terminal Blocks as industrial wastes.
- Do not wire anything to the release holes.
- Do not tilt or twist a flat-blade screwdriver while it is inserted into a release hole on the terminal block. The terminal block may be damaged.
- Insert a flat-blade screwdriver into the release holes at an angle. The terminal block may be damaged if you insert the screwdriver straight in.
- Do not allow the flat-blade screwdriver to fall out while it is inserted into a release hole.
- Do not bend a wire past its natural bending radius or pull on it with excessive force. Doing so may sever the cable. Do not apply excessive force to the Terminal Blocks. Doing so may cause connection failure due to damage or deformation.
- Do not insert more than one wire into each terminal insertion hole.
- When mounting multiple Terminal Blocks, mount them so that the conductive parts of the adjacent Terminal Blocks are facing in the same direction. If they face in different directions, short circuit may occur between adjacent Terminal Blocks.
- Do not use wires with discoloration, doing so may cause conduction failure.
- When stripping the wire coatings, be sure not to damage the core wire. Doing so may cause connection failure.
- Do not perform wiring with wet hands. Doing so may result operation failure or malfunction when power is supplied.

- To prevent wiring materials from smoking or ignition, use the wiring materials given in the following table with referring the ratings of wires.

	Recommended wire		Stripping length (Ferrules not used)
	Solid wire	Stranded wire	
XW6T-COM1.5X□□□□	0.14 to 1.5 mm <sup>2</sup> / AWG 26 to 14	0.08 to 1.5 mm <sup>2</sup> / AWG 28 to 16	8 mm
XW6T-COM2.5X□□□□	0.14 to 4.0 mm <sup>2</sup> / AWG 26 to 12	0.14 to 2.5 mm <sup>2</sup> / AWG 26 to 14	10 mm

**Precautions for Correct Use**

**1. Precautions for Correct Use**

- Always mount End Covers to the following locations when you use Terminal Blocks.
- Exposed metal surface of the last Terminal Block
- Any Terminal Block that is next to a different shape of Terminal Blocks.

Not doing so may result electrical shock.

- When you wire the Terminal Block, do not subject it or the wires to stress. Secure the wires so that they do not resonate with vibrations from the facilities in installation conditions.
- Always turn OFF the power supply before wiring. Electrical shock may occur.
- Do not insert a flat-blade screwdriver into the indicator part. Doing so may cause failure of function that indicates wire insertion state.
- When you use stranded wires thinner than AWG22 (0.34 mm<sup>2</sup> or equivalent), the wire insertion state indication may not properly function due to low rigidity of the conductive part. Use of ferrules is recommended when using wires thinner than AWG22.

**2. Connecting Wires to the Push-In Plus Terminal Block**

**Part Names of the Terminal Block**

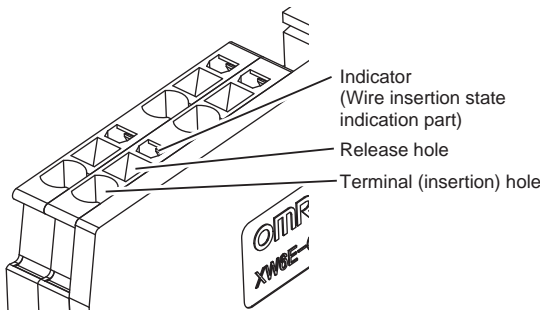

**Connecting Wires with Ferrules (hereinafter referred to as Ferrules) and Solid Wires**

Insert the solid wire or ferrule straight into the Terminal Block until the end strikes the Terminal Block. If a wire is difficult to connect because it is too thin, use a flat-blade screwdriver in the same way as when connecting stranded wire. When the wire is inserted, the wire insertion state indication part turns green.

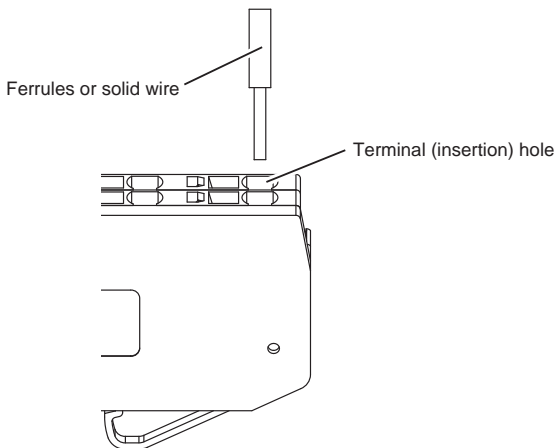

**Connecting Stranded Wires**

Use the following procedure to connect the wires to the terminal block.

1. Hold a flat-blade screwdriver at an angle and insert it into the release hole. The angle should be between 10° and 15°. If the flat-blade screwdriver is inserted correctly, you will feel the spring in the release hole respond.
2. With the flat-blade screwdriver still inserted into the release hole, insert the wire into the terminal hole until it strikes the terminal block. Always twist stranded wires together before inserting them. When the wire is inserted, the wire insertion state indication part turns in green.
3. Remove the flat-blade screwdriver from the release hole.

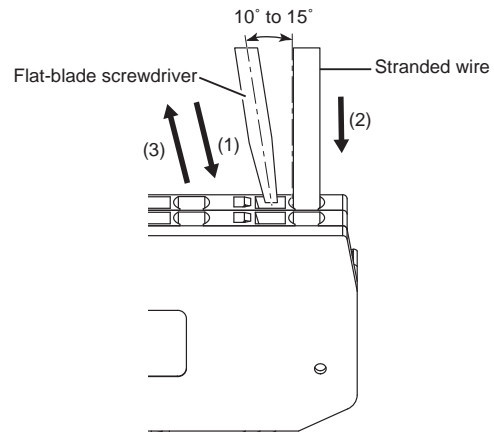

**Checking Connections**

- When you complete wiring, an indicator for the wire insertion state turns to green.
- To prevent short circuits, insert the stripped part of a stranded or solid wire or the conductor part of a ferrule until it is hidden inside the terminal insertion hole.
- After the connection, the wire insertion state indication of the indicator may shift by a load applied to the wire at wiring or other causes. Even in such a case, there is no problem in the electrical connection as long as the indicator shows a part of green to indicate the proper insertion of wire.



Wire non-insertion state: Green is not indicated.



Wire insertion state: Green is indicated.

**3. Removing Wires from the Push-In Plus Terminal Block**

Use the following procedure to remove wires from the terminal block. The same method is used to remove stranded wires, solid wires, and ferrules.

1. Hold a flat-blade screwdriver at an angle and insert it into the release hole.
2. With the flat-blade screwdriver still inserted into the release hole, remove the wire from the terminal insertion hole.
3. Remove the flat-blade screwdriver from the release hole.

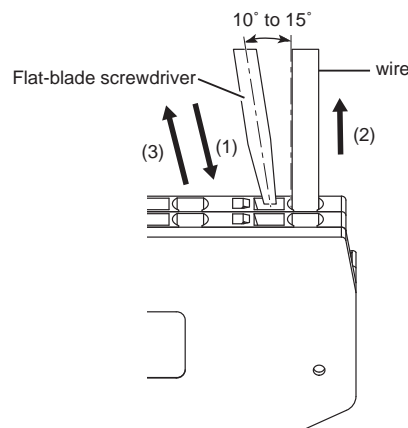



## 4. Recommended Ferrules and Crimp Tools

### Recommended ferrules

XW6T-COM1.5X□□□□

Applicable wire		Ferrule Conductor length (mm)	Stripping length (mm) (Ferrules used)	Recommended ferrules		
(mm <sup>2</sup> )	(AWG)			Manufactured by Phoenix Contact *	Manufactured by Weidmuller	Manufactured by Wago
0.14	26	8	10	AI 0,14-8	H0.14/12	---
0.25	24	8	10	AI 0,25-8	H0.25/12	216-301
		10	12	AI 0,25-10	---	---
0.34	22	8	10	AI 0,34-8	H0.34/12	216-302
		10	12	AI 0,34-10	---	---
0.50	20	8	10	AI 0,5-8	H0.5/14	216-201
		10	12	AI 0,5-10	H0.5/16	216-241
0.75	18	8	10	AI 0,75-8	H0.75/14	216-202
		10	12	AI 0,75-10	H0.75/16	216-242
Recommended crimp tools				CRIMPFOX6 CRIMPFOX6T-F CRIMPFOX10S	PZ6 roto	Variocrimp4

\* The above recommended ferrules manufactured by Phoenix Contact do not include models ending in "-GB".

Models ending in "-GB" are not recommended because the inner diameter of the insulation sleeve is larger than standard models (models not ending in "-GB").

- Note:** 1. Make sure that the outer diameter of the wire is smaller than the inner diameter of the insulation sleeve of the recommended ferrule.  
2. Make sure that the ferrule processing dimensions conform to the following figure.

#### Processing dimensions of ferrules

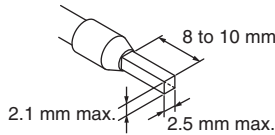

3. For the ferrule which is for applicable wire (1 to 1.5 mm<sup>2</sup>/ AWG 18 to 16), please use a ferrule without an insulation sleeve. (Refer to the following table.)

Applicable wire		Ferrule Conductor length (mm)	Stripping length (mm) (Ferrules used)	Recommended ferrules		
(mm <sup>2</sup> )	(AWG)			Manufactured by Phoenix Contact	Manufactured by Weidmuller	Manufactured by Wago
1/1.25	18/17	8	8	A 1-8	---	F-1.0-8
		10	10	A 1-10	H1,0/10	F-1.0-10
1.25/1.5	17/16	10	10	A 1,5-10	H1,5/10	F-1.5-10
Recommended crimp tools				CRIMPFOX6 CRIMPFOX6T-F CRIMPFOX10S	PZ6 roto	Variocrimp4

XW6T-COM2.5X□□□□

Applicable wire		Ferrule Conductor length (mm)	Stripping length (mm) (Ferrules used)	Recommended ferrules		
(mm <sup>2</sup> )	(AWG)			Manufactured by Phoenix Contact	Manufactured by Weidmuller	Manufactured by Wago
0.14	26	8	10	AI 0,14-8	H0.14/12	---
0.25	24	8	10	AI 0,25-8	H0.25/12	216-301
		10	12	AI 0,25-10	---	---
0.34	22	8	10	AI 0,34-8	H0.34/12	216-302
		10	12	AI 0,34-10	---	---
0.50	20	8	10	AI 0,5-8	H0.5/14	216-201
		10	12	AI 0,5-10	H0.5/16	216-241
0.75	18	8	10	AI 0,75-8	H0.75/14	216-202
		10	12	AI 0,75-10	H0.75/16	216-242
1/1.25	18/17	8	10	AI 1-8	H1.0/14	216-203
		10	12	AI 1-10	H1.0/16	216-243
1.25/1.5	17/16	8	10	AI 1,5-8	H1.5/14	216-204
		10	12	AI 1,5-10	H1.5/16	216-244
2.5	14	10	12	AI 2,5-10	H2.5/16DS	216-246
Recommended crimp tools				CRIMPFOX6 CRIMPFOX6T-F CRIMPFOX10S	PZ6 roto	Variocrimp4

- Note:** 1. Make sure that the outer diameter of the wire is smaller than the inner diameter of the insulation sleeve of the recommended ferrule.  
2. Make sure that the ferrule processing dimensions conform to the following figure.

#### Processing dimensions of ferrules

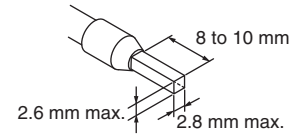

### Recommended Flat-blade Screwdriver

Use a flat-blade screwdriver to connect and remove wires. Use the following flat-blade screwdriver. The following table shows manufacturers and models as of 2018/Dec.

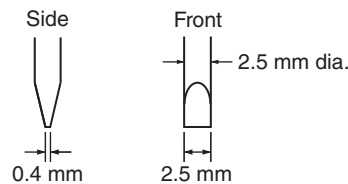

Model	Manufacturer
ESD 0,40x2,5	Wera
SZS 0,4x2,5 SZF 0-0,4x2,5 *	Phoenix Contact
0.4x2.5x75 302	Wiha
AEF.2,5x75	Facom
210-719	Wago
SDIS 0.4x2.5x75	Weidmuller
9900(-2.5x75)	Vessel

\* OMRON's exclusive purchase model XW4Z-00B is available to order as SZF 0-0,4 x 2,5 (manufactured by Phoenix Contact).

## 5. Mounting to DIN Track/Removing from DIN Track

### Mounting Method

- To mount a Terminal Block to a DIN Track, press it against the DIN Track as shown in the following figure.
- \* Even when Terminal Block seems like tilting before mounting it on the DIN Track, it is no problem for the functions.
- After mounting, push Short Bar securely and check it for no gap or no tilting.



### Removal Method

To remove a Terminal Block from the DIN Track, insert the tip of a flat-blade screwdriver in the groove on the Short Bar, remove the Short Bar so that lifting it up from the Terminal Block (1), operate the screwdriver so that it catches the hook (2), and then remove the Terminal Block with the divided state (3). However, do not apply excessive force to the Terminal Block. Doing so may damage it.

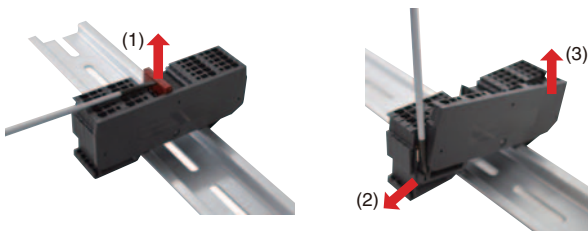

### Replacing Method



- Mount the Terminal Block with divided state on the DIN Track.
- Insert Short Bars into the insertion holes for Short Bars.
- Insert Short Bars for securely.

## Adding Method of Common Terminal Blocks

- Remove the End Cover.

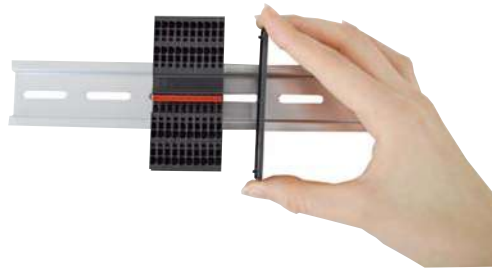

- Mount a Common Terminal Block (for addition) on the DIN Track.
- Replace the End Cover.

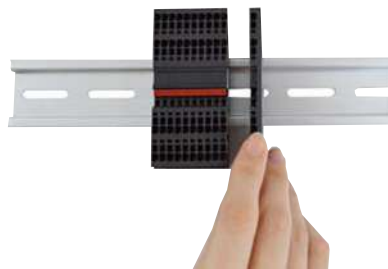

- Mount a Short Bar so that it overlaps with the existing Short Bar.

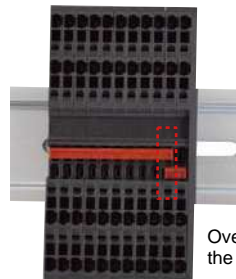

Overlapping Short Bars enables to add the number of Common Terminal Blocks.

## 6. Storage

### Ambient storage temperature

-40 to 85°C (with no condensation or icing)

### Ambient storage humidity

5 to 95%RH

# Terms and Conditions Agreement

## **Read and understand this catalog.**

Please read and understand this catalog before purchasing the products. Please consult your OMRON representative if you have any questions or comments.

## **Warranties.**

- (a) Exclusive Warranty. Omron's exclusive warranty is that the Products will be free from defects in materials and workmanship for a period of twelve months from the date of sale by Omron (or such other period expressed in writing by Omron). Omron disclaims all other warranties, express or implied.
- (b) Limitations. OMRON MAKES NO WARRANTY OR REPRESENTATION, EXPRESS OR IMPLIED, ABOUT NON-INFRINGEMENT, MERCHANTABILITY OR FITNESS FOR A PARTICULAR PURPOSE OF THE PRODUCTS. BUYER ACKNOWLEDGES THAT IT ALONE HAS DETERMINED THAT THE PRODUCTS WILL SUITABLY MEET THE REQUIREMENTS OF THEIR INTENDED USE.

Omron further disclaims all warranties and responsibility of any type for claims or expenses based on infringement by the Products or otherwise of any intellectual property right. (c) Buyer Remedy. Omron's sole obligation hereunder shall be, at Omron's election, to (i) replace (in the form originally shipped with Buyer responsible for labor charges for removal or replacement thereof) the non-complying Product, (ii) repair the non-complying Product, or (iii) repay or credit Buyer an amount equal to the purchase price of the non-complying Product; provided that in no event shall Omron be responsible for warranty, repair, indemnity or any other claims or expenses regarding the Products unless Omron's analysis confirms that the Products were properly handled, stored, installed and maintained and not subject to contamination, abuse, misuse or inappropriate modification. Return of any Products by Buyer must be approved in writing by Omron before shipment. Omron Companies shall not be liable for the suitability or unsuitability or the results from the use of Products in combination with any electrical or electronic components, circuits, system assemblies or any other materials or substances or environments. Any advice, recommendations or information given orally or in writing, are not to be construed as an amendment or addition to the above warranty.

See <http://www.omron.com/global/> or contact your Omron representative for published information.

## **Limitation on Liability; Etc.**

OMRON COMPANIES SHALL NOT BE LIABLE FOR SPECIAL, INDIRECT, INCIDENTAL, OR CONSEQUENTIAL DAMAGES, LOSS OF PROFITS OR PRODUCTION OR COMMERCIAL LOSS IN ANY WAY CONNECTED WITH THE PRODUCTS, WHETHER SUCH CLAIM IS BASED IN CONTRACT, WARRANTY, NEGLIGENCE OR STRICT LIABILITY.

Further, in no event shall liability of Omron Companies exceed the individual price of the Product on which liability is asserted.

## **Suitability of Use.**

Omron Companies shall not be responsible for conformity with any standards, codes or regulations which apply to the combination of the Product in the Buyer's application or use of the Product. At Buyer's request, Omron will provide applicable third party certification documents identifying ratings and limitations of use which apply to the Product. This information by itself is not sufficient for a complete determination of the suitability of the Product in combination with the end product, machine, system, or other application or use. Buyer shall be solely responsible for determining appropriateness of the particular Product with respect to Buyer's application, product or system. Buyer shall take application responsibility in all cases.

NEVER USE THE PRODUCT FOR AN APPLICATION INVOLVING SERIOUS RISK TO LIFE OR PROPERTY OR IN LARGE QUANTITIES WITHOUT ENSURING THAT THE SYSTEM AS A WHOLE HAS BEEN DESIGNED TO ADDRESS THE RISKS, AND THAT THE OMRON PRODUCT(S) IS PROPERLY RATED AND INSTALLED FOR THE INTENDED USE WITHIN THE OVERALL EQUIPMENT OR SYSTEM.

## **Programmable Products.**

Omron Companies shall not be responsible for the user's programming of a programmable Product, or any consequence thereof.

## **Performance Data.**

Data presented in Omron Company websites, catalogs and other materials is provided as a guide for the user in determining suitability and does not constitute a warranty. It may represent the result of Omron's test conditions, and the user must correlate it to actual application requirements. Actual performance is subject to the Omron's Warranty and Limitations of Liability.

## **Change in Specifications.**

Product specifications and accessories may be changed at any time based on improvements and other reasons. It is our practice to change part numbers when published ratings or features are changed, or when significant construction changes are made. However, some specifications of the Product may be changed without any notice. When in doubt, special part numbers may be assigned to fix or establish key specifications for your application. Please consult with your Omron's representative at any time to confirm actual specifications of purchased Product.

## **Errors and Omissions.**

Information presented by Omron Companies has been checked and is believed to be accurate; however, no responsibility is assumed for clerical, typographical or proofreading errors or omissions.

Some images are used under license from Shutterstock.com.

**Note: Do not use this document to operate the Unit.**

**OMRON Corporation Industrial Automation Company**  
Kyoto, JAPAN

Contact: [www.ia.omron.com](http://www.ia.omron.com)

**Regional Headquarters**

**OMRON EUROPE B.V.**

Wegalaan 67-69, 2132 JD Hoofddorp  
The Netherlands  
Tel: (31)2356-81-300/Fax: (31)2356-81-388

**OMRON ELECTRONICS LLC**

2895 Greenspoint Parkway, Suite 200  
Hoffman Estates, IL 60169 U.S.A.  
Tel: (1) 847-843-7900/Fax: (1) 847-843-7787

**OMRON ASIA PACIFIC PTE. LTD.**

438B Alexandra Road, #08-01/02 Alexandra  
Technopark, Singapore 119968  
Tel: (65) 6835-3011/Fax: (65) 6835-2711

**OMRON (CHINA) CO., LTD.**

Room 2211, Bank of China Tower,  
200 Yin Cheng Zhong Road,  
PuDong New Area, Shanghai, 200120, China  
Tel: (86) 21-5037-2222/Fax: (86) 21-5037-2200

**Authorized Distributor:**

© OMRON Corporation 2019-2022 All Rights Reserved.  
In the interest of product improvement,  
specifications are subject to change without notice.

**CSM\_3\_2**  
**Cat. No. G139-E1-04**

0622 (0319)