

HOBO® Pendant® MX Temp (MX2201) and Temp/Light (MX2202) Logger Manual



MX2201 Model Shown

HOBO Pendant MX Logger

Models:

- MX Temp (MX2201)
- MX Temp/Light (MX2202)

Required Items:

- HOBObconnect app
- Mobile device with Bluetooth and iOS, iPadOS®, or Android™, or a Windows computer with a native BLE adapter or supported BLE dongle

Accessories:

- Mounting boot 5-pack (BOOT-MX2201-2202)
- Solar radiation shield (RS1 or M-RSA)
- Mounting bracket for solar radiation shield (MX2200-RS-BRACKET)
- Replacement O-rings (MX2201-02-ORING)

HOBO Pendant MX loggers measure temperature (MX2201) or temperature/light (MX2202) in indoor and outdoor environments. Designed for durability, these compact, waterproof loggers can be used in numerous applications, including fresh and salt water. The loggers are Bluetooth® Low Energy-enabled for wireless communication with a phone, tablet, or computer. Using the HOBObconnect® app, you can easily configure the loggers, download logged data to a mobile device or computer, or automatically upload the data to HOBOLink® for further analysis. You can also configure the loggers to calculate statistics, set up alarms to trip at specific thresholds, or enable burst logging in which data is logged at a faster interval when sensor readings are above or below certain limits.

Specifications

Temperature Sensor (MX2201 and MX2202)

Range	-20° to 70°C (-4° to 158°F) in air -20° to 50°C (-4° to 122°F) in water
Accuracy	±0.5°C from -20° to 70°C (-4° to 158°F)
Resolution	0.04°C (0.072°F)
Drift	<0.1°C (0.18°F) per year
Response Time	17 minutes typical to 90% in air moving 1 m/s, unmounted 7 minutes typical to 90% in stirred water, unmounted

Light Sensor (MX2202)

Range	0 to 167,731 lux (15,582 lum/ft ²)
Accuracy	±10% typical for direct sunlight (see <i>Light Measurement</i> on page 2)

Logger

Logger Operating Range	-20° to 70°C (-4° to 158°F) in air
Buoyancy (Fresh Water)	2 g (0.07 oz) positive
Waterproof	To 30.5 m (100 ft)
Radio Power	1 mW (0 dBm)
Transmission Range	Approximately 30.5 m (100 ft) line-of-sight
Wireless Data Standard	Bluetooth Low Energy (Bluetooth Smart)
Logging Rate	1 second to 18 hours
Time Accuracy	±1 minute per month at 25°C (77°F)
Battery	CR2032 3V lithium, user replaceable

Battery Life

1 year typical at 25°C (77°F) with logging interval of 1 minute and Bluetooth Always On enabled in software.

2 years typical at 25°C (77°F) with logging interval of 1 minute and Bluetooth Always On disabled in software.

Faster logging intervals and statistics sampling intervals, burst logging, remaining connected with the app, excessive downloads, and paging may impact battery life.

To ensure proper battery installation, see *Battery Information* for detailed instructions on replacing the battery.

Memory	96,000 measurements
Full Memory Download Time	Approximately 45 seconds; may take longer the farther the device is from the logger
Wetted Materials	Polypropylene case, Acetal back cover, EPDM O-ring TPE Mounting Boot
Dimensions	3.35 x 5.64 x 1.8 cm (1.32 x 2.22 x 0.69 inches)
Weight	12.75 g (0.45 oz)
Environmental Rating	IP68



The CE Marking identifies this product as complying with all relevant directives in the European Union (EU).



See last page

Logger Components and Operation

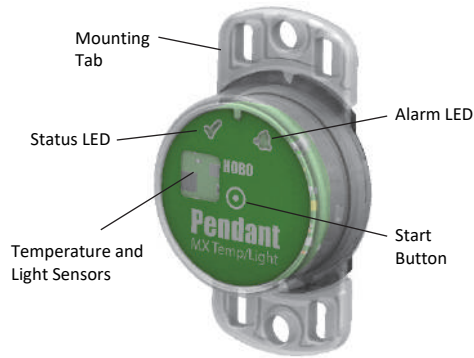

MX2202 model shown

Mounting Tab: Use the tabs at the top and bottom of the logger to mount it (see *Deploying and Mounting the Logger*).

Temperature and Light Sensors: The temperature sensor (MX2201 and MX2202) and light sensor (MX2202) are located on the right side of the logger. See *Light Measurement* for more details on the light sensor.

Status LED: This LED blinks green every 4 seconds when the logger is logging (unless Show LED is disabled as described in *Configuring the Logger*). If the logger is waiting to start logging because it was configured to start On Button Push or with a delayed start, it blinks green every 8 seconds. Both this LED and the Alarm LED blink once when you press the start button to wake up the logger before configuring it. If you select Illuminate Logger in the app, both LEDs light up for 5 seconds (see *Getting Started* for more details).

Alarm LED: This LED blinks red every 4 seconds when an alarm is tripped (unless Show LED is disabled as described in *Configuring the Logger*).

Start Button: Press the button on the front of the logger case for 1 second to wake up the logger (unless Bluetooth Always On is enabled as described in *Configuring the Logger*). Both LEDs blink and the logger moves to the top of the devices list in the app. You may need to press the button a second time to wake up the logger if it is logging every 5 seconds or faster and the temperature is -10°C (14°F) or below. Press the button for 3 seconds to start or stop the logger when it is configured to start or stop On Button Push (see *Configuring the Logger*). Both LEDs blink four times when you press the button to start or stop logging. Press the button for 10 seconds to reset a password.

Note: The circle on the front of the logger represents the button area on the logger. You will not feel an actual button push when you press that area; this is normal.

Light Measurement (MX2202)

The logger measures light intensity in units of lumens/ft² or lux. The light sensor in the MX2202 has a spectral response that tightly matches the photopic response of the human eye. This is shown in Plot A.

The light sensor has range of 0 to 167,731 lux (15,582 lum/ft²). The resolution of the light measurement varies from 1 unit of lux or lum/ft² in very dim light to 40 lux (4 lum/ft²) for a full scale measurement.

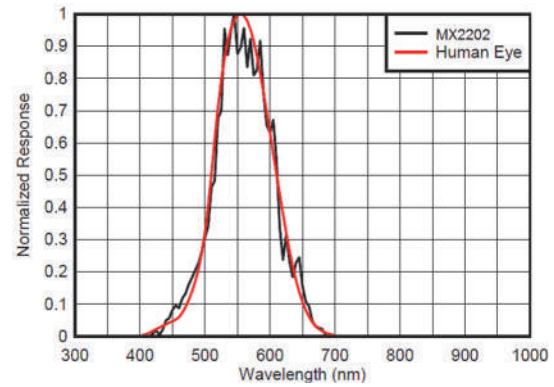

Plot A

Light Measurement Accuracy

Although the MX2202 is factory calibrated to account for the light attenuation of the plastic enclosure, you may notice a significant difference in the MX2202 reading compared to a commercially available lux meter. Ideally, a light meter's response should be proportional to the cosine of the angle at which the light is incident. The MX2202 does not collect light exactly according to this rule. Plot B illustrates the difference between an ideal cosine response and the approximate response of the MX2202. For example, given an incident angle of 60° , the MX2202 response is 40% lower than the ideal response. The MX2202 is calibrated to give best results for direct illumination, but this is not always the case.

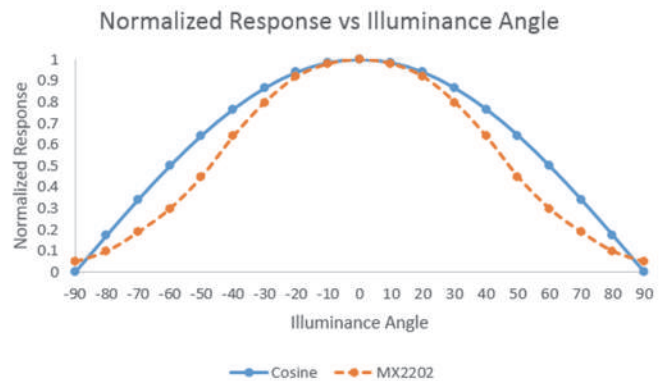

Plot B

Getting Started







Install the app to connect to and work with the logger.

1. Download HOBObconnect to a phone or tablet from the App Store® or Google Play™. Download the app to a Windows computer from www.onsetcomp.com/products/software/hobobconnect.
2. Open the app and enable Bluetooth in the device settings if prompted.
3. Firmly press the circular button near the center of the logger to wake it up. Both LEDs on the logger blink once when it wakes up.
4. Tap Devices and then tap the logger in the app to connect to it.

If the logger does not appear or if it is having trouble connecting, follow these tips.

- Make sure the logger is “awake” by pressing the circle button on the logger. The alarm and status LEDs blink once when the logger wakes up. This also brings the logger to the top of the list if you are working with multiple loggers.
- If the logger is currently logging at a fast interval (5 seconds or faster) and the temperature is -10°C (14°F) or below, you may need to press the button twice before it appears in the list.
- Make sure the logger is within range of your mobile device or computer. The range for successful wireless communication in air is approximately 30.5 m (100 ft) with full line-of-sight.
- Change the orientation of your device to ensure the antenna is pointed toward the logger. Obstacles between the antenna in the device and the logger may result in intermittent connections.
- If your device can connect to the logger intermittently or loses its connection, move closer to the logger, within sight if possible. If the logger is in water, the connection can be unreliable. Remove it from water for a consistent connection.
- If the logger appears in the app, but you cannot connect to it, close the app and then power down your device to force the previous Bluetooth connection to close.

Once the logger is connected, you can:

Tap this:	To do this:
	Specify logger settings and save them to the logger to start logging. See <i>Configuring the Logger</i> .
	Download logger data. See <i>Downloading Data From the Logger</i> .
	Start logging if the logger was configured to start On Button Push. See <i>Configuring the Logger</i> .
	Stop logging data (this overrides any Stop Logging settings described in <i>Configuring the Logger</i>).
	Illuminate the logger LEDs for 5 seconds.
	Set a password for the logger that is required when another mobile device attempts to connect to it. To reset a password, press the button on the logger for 10 seconds or tap Manage Password and tap Reset.
	Mark the logger as a favorite. You can then filter the list of devices to show only loggers marked as favorites.



Update the firmware on the logger. A logger readout is completed automatically at the beginning of the firmware update process.

Important: Before updating the firmware on the logger, check the remaining battery level and make sure it is no less than 30%. Make sure you have the time to complete the entire update process, which requires that the logger remains connected to the device during the upgrade.

Configuring the Logger

Use the app to set up the logger, including selecting the logging interval, start and stop logging options, and configuring alarms. These steps provide an overview of setting up the logger. For complete details, see the HOBObconnect User’s Guide.

Note: Specify settings that are important to you. Press Start at any time to accept the defaults.

1. Tap Devices and then tap the logger to connect to it. If the logger was configured with Bluetooth Always On disabled, firmly press the circle button on the logger to wake it up. This also brings the logger to the top of the logger list.
2. Tap Configure & Start to configure the logger.
3. Tap Name and type a name for the logger (optional). If you do not enter a name, the app uses logger serial number as the name.
4. Tap Group to add the logger to a group (optional).
5. Tap Logging Interval and choose how frequently the logger records data when not in burst logging mode (see *Burst Logging*).
6. Tap Start Logging and select when logging begins:
 - **On Save.** Logging begins immediately after configuration settings are saved.
 - **On Next Interval.** Logging begins at the next even interval as determined by the selected logging interval setting.
 - **On Button Push.** Logging begins when you press the button on the logger for 3 seconds.
 - **On Date/Time.** Logging begins at a date and time you specify. Specify the date and time.
7. Tap Stop Logging and specify when logging ends.
 - **Never Stop (Overwrites Old Data).** The logger does not stop at any predetermined time. The logger continues recording data indefinitely, with newest data overwriting the oldest.
 - **On Date/Time.** The logger stops logging on a specific date and time that you specify.
 - **After.** Select this if you want to control how long the logger should continue logging once it starts. Choose the amount of time you want the logger to log data. For example, select 30 days if you want the logger to log data for 30 days after logging begins.
 - **Stop When Memory Fills.** The logger continues recording data until the memory is full.

8. Tap Pause Options, then select Pause On Button Push to specify that you can pause the logger by pressing its button for 3 seconds.
9. Tap Logging Mode. Select either Fixed or Burst logging. Fixed logging records data for all enabled sensors and/or selected statistics at the logging interval selected (see *Statistics Logging* for details on choosing statistics options). Burst mode logs at a different interval when a specified condition is met. See *Burst Logging* for more information.
10. Enable or disable Show LED. If Show LED is disabled, the alarm and status LEDs on the logger do not illuminate while logging (the alarm LED does not blink if an alarm trips). You can temporarily turn on LEDs when Show LED is disabled by pressing the button on the logger for 1 second.
11. Enable or disable Bluetooth Always On. When this option is enabled, the logger advertises or regularly sends out a Bluetooth signal for the phone, tablet, or computer to find via the app while it is logging, which uses battery power. When this option is disabled, the logger advertises only during logging when you press the circle button on the logger to wake it up. This preserves battery power.
12. Upload Data Via allows you to specify whether to upload data to HOBOLink using a HOBO Gateway or HOBOLink.
13. For the Pendant MX Temp/Light (MX2202) logger, both the temperature and light sensors are enabled by default. Disable one if desired by tapping to toggle it to the off position.
14. Set up alarms to trip when a sensor reading rises above or falls below a specified value. See *Setting up Alarms* for details on enabling sensor alarms.
15. Tap Start to save the configuration settings and start logging.

Logging begins based on the settings you specified. See *Deploying and Mounting the Logger* for details on mounting and see *Downloading Data From the Logger* for details on downloading.

Setting up Alarms

You can set up alarms for the logger that trip when a sensor reading rises above or falls below a specified value. The logger alarm LED blinks and an alarm icon appears in the app. This alerts you to problems so you can take corrective action.

To set an alarm:

1. Tap Devices. Press the button **on the logger** to wake it up, if necessary.
2. Tap the logger in the app to connect to it and tap Configure & Start.
3. Tap a Sensor/Channel.
4. Tap Enable Logging, if necessary.
5. Tap Alarms to open that area of the screen.
6. Select Low if you want an alarm to trip when the sensor reading falls below the low alarm value. Enter a value to set the low alarm value.
7. Select High if you want an alarm to trip when the sensor reading rises above the high alarm value. Enter a value to set the high alarm value.
8. For the Duration, select how much time should elapse before the alarm trips and select one of the following:

- Cumulative Samples. The alarm trips once the sensor reading is out of the acceptable range for the selected duration any time during logging. For example, if the high alarm is set to 85°F and the duration is set to 30 minutes, then the alarm trips once the sensor readings have been above 85°F for a total of 30 minutes since the logger was configured.
 - Consecutive Samples. The alarm trips once the sensor reading is out of the acceptable range continuously for the selected duration. For example, the high alarm is set to 85°F and the duration is set to 30 minutes, then the alarm trips only if all sensor readings are 85°F or above for a continuous 30-minute period.
9. Repeat steps 3–8 for the other sensor if desired. Note that when both alarms are configured, an alarm is raised when either sensor is in an alarm condition.
 10. In the Alarm Settings area, select one of the following options to determine how the alarms are cleared:

- **Logger Reconfigured.** The alarm indication appears until the next time the logger is reconfigured.
- **Sensor in Limits.** The alarm icon indication appears until the sensor reading returns to the normal range between any configured high and low alarm limits.

When an alarm trips, the logger alarm LED blinks every 4 seconds (unless Show LED is disabled), an alarm icon appears in the app, and an Alarm Tripped event is logged. The alarm state clears when the readings return to normal if you selected Sensor in Limits in step 10. Otherwise, the alarm state remains in place until the logger is reconfigured.

Notes:

- The logger checks alarm limits at every logging interval. For example, if the logging interval is set to 5 minutes, the logger checks the sensor readings against your configured high and low alarm setting every 5 minutes.
- The actual values for the high and low alarm limits are set to the closest value supported by the logger. In addition, alarms can trip or clear when the sensor reading is within the resolution specifications.
- When you download data from the logger, alarm events can be displayed on the plot or in the data file. See *Logger Events*.

Burst Logging

Burst logging is a logging mode that allows you to set up more frequent logging when a specified condition is met. For example, a logger is recording data at a 5-minute logging interval and burst logging is configured to log every 30 seconds when the temperature rises above 85°F (the high limit) or falls below 32°F (the low limit). This means the logger records data every 5 minutes as long as the temperature remains between 85°F and 32°F. Once the temperature rises above 85°F, the logger switches to the faster logging rate and records data every 30 seconds until the temperature falls back to 85°F. At that time, logging then resumes every 5 minutes at the normal logging interval. Similarly, if the temperature falls below 32°F, the logger switches to burst logging mode again and records data every 30 seconds. Once the temperature rises back to 32°F, the logger then returns to normal mode, logging every 5 minutes. **Note:** Sensor alarms, statistics, and the Stop Logging

option Never Stop (Overwrites Old Data) are not available in burst logging mode.

To set up burst logging:

1. Tap Devices. Press the button **on the logger** to wake it up (if necessary).
2. Tap the logger tile in the app to connect to it and tap Configure & Start.
3. Tap Logging Mode and then tap Burst Logging.
4. Set the burst logging interval, which must be faster than the logging interval. Keep in mind that the faster the burst logging rate, the greater the impact on battery life and the shorter the logging duration. Because measurements are being taken at the burst logging interval throughout the deployment, the battery usage is similar to what it would be if you had selected this rate for the normal logging interval.
5. Select Low and/or High and type a value to set the low and/or high values.
6. Repeat step 5 for the other sensor if desired.

Notes:

- The high and low burst limits are checked at the burst logging interval rate whether the logger is in normal or burst condition. For example, if the logging interval is set to 1 hour and the burst logging interval is set to 10 minutes, the logger always checks for burst limits every 10 minutes.
- If high and/or low limits have been configured for more than one sensor, then burst logging begins when any high or low condition goes out of range. Burst logging does not end until all conditions on all sensors are back within normal range.
- The actual values for the burst logging limits are set to the closest value supported by the logger. In addition, burst logging can begin or end when the sensor reading is within the specified resolution. This means the value that triggers burst logging may differ slightly from the value entered.
- Once the high or low condition clears, the logging interval time is calculated using the last recorded data point in burst logging mode, not the last data point recorded at the normal logging rate. For example, the logger has a 10-minute logging interval and logged a data point at 9:05. Then, the high limit was surpassed and burst logging began at 9:06. Burst logging then continued until 9:12 when the sensor reading fell back below the high limit. Now back in normal mode, the next logging interval is 10 minutes from the last burst logging point, or 9:22 in this case. If burst logging had not occurred, the next data point would have been at 9:15.
- A New Interval event is created each time the logger enters or exits burst logging mode. See *Logger Events* for details on plotting and viewing the event. In addition, if the logger is stopped with a button push while in burst logging mode, a New Interval event is automatically logged and the burst condition is cleared, even if the actual high or low condition has not cleared.

Statistics Logging

During fixed logging, the logger records data for enabled sensors and/or selected statistics at the specified logging

interval. Statistics are calculated at a sampling rate you specify with the results for the sampling period recorded at each logging interval. You can log the following statistics for each sensor:

- The maximum, or highest, sampled value
- The minimum, or lowest, sampled value
- An average of all sampled values
- The standard deviation from the average for all sampled values

For example, a Pendant MX Temp/Light (MX2202) logger is configured with both the temperature and light sensors enabled, and the logging interval set to 5 minutes. It is set to Fixed Logging Mode with all four statistics enabled and a statistics sampling interval of 30 seconds. Once logging begins, the logger measures and records the actual temperature and light values every 5 minutes. In addition, the logger takes a temperature and light sample every 30 seconds and temporarily stores them in memory. The logger then calculates the maximum, minimum, average, and standard deviation using the samples gathered over the previous 5-minute period and logs the resulting values. When downloading data from the logger, this results in 10 data series: two sensor series (with temperature and light data logged every 5 minutes) plus eight maximum, minimum, average, and standard deviation series (four for temperature and four for light with values calculated and logged every 5 minutes based on the 30-second sampling).

To log statistics:

1. Tap Devices. Press the Start/Stop button **on the logger** to wake it up, if necessary.
2. Tap the logger tile in the app to connect to it and tap Configure & Start.
3. Tap Logging Mode and then select Fixed Logging Mode.
4. Tap to turn on Statistics.

Note: Fixed Logging Mode records sensor measurements taken at each logging interval. The selections you make in the Statistics section add measurements to the recorded data.
5. Select the statistics you want the logger to record at each logging interval: Maximum, Minimum, Average, and Standard Deviation (average is automatically enabled when selecting Standard Deviation). Statistics are logged for all enabled sensors. In addition, the more statistics you record, the shorter the logger duration and the more memory is required.
6. Enter a value in Statistics Sampling Interval to use for calculating statistics. The rate must be less than, and a factor of, the logging interval. For example, if the logging interval is 1 minute and you select 5 seconds for the sampling rate, the logger takes 12 sample readings between each logging interval (one sample every 5 seconds for a minute) and use the 12 samples to record the resulting statistics at each 1-minute logging interval. Note that the faster the sampling rate, the greater the impact on battery life. Because measurements are being taken at the statistics sampling interval throughout the deployment, the battery usage is similar to what it would be if you had selected this rate for the normal logging interval.

Setting a Password

You can create an encrypted password for the logger that is required if another device attempts to connect to it. This is recommended to ensure that a deployed logger is not mistakenly stopped or purposely altered by others. This password uses a proprietary encryption algorithm that changes with every connection.

To set a password:

1. Tap Devices. Press the button **on the logger** to wake it up, if necessary. Tap the logger tile in the app to connect to it.
2. Tap Lock Logger.
3. Type a password and then tap Set.

Only the device used to set the password can then connect to the logger without entering a password; all other devices are required to enter the password. For example, if you set the password for the logger with your tablet and then try to connect to the logger later with your phone, you must enter the password on the phone but not with your tablet. Similarly, if others attempt to connect to the logger with different devices, they are also required to enter the password. To reset a password, press the button on the logger for 10 seconds or connect to the logger and tap Manage Password and tap Reset.

Downloading Data From the Logger

To download data from the logger:



1. Tap Devices. Press the circle button **on the logger** to wake it up, if necessary. Tap the logger tile in the app to connect to it.
2. Tap Download Data. The logger downloads data to the phone, tablet, or computer.
3. Once the download is complete tap Done to return to the previous page or tap Export and Share to save the file in the specified format.
4. When the export file has successfully been created, tap Done to return to the previous page or tap Share to use your device's usual modes of sharing.

You can also upload data automatically to HOBOLink, Onset's web-based software, using the app or the MX gateway. For details, see the HOBOLink User Guide and see the HOBOLink help for details on working with data in HOBOLink.

Logger Events

The logger records the following events to track logger operation and status. You can view events in exported files or plot events in the app.

To plot events, tap Data and select a file to open.

Tap  (if applicable) and then tap . Select the events you want to plot and tap OK.

Event Name	Definition
Host Connect	The logger was connected to a mobile device.
Started	The logger started logging.
Stopped	The logger stopped logging.

Event Name	Definition
Chan <#> Alarm Tripped/Cleared	An alarm has occurred because the reading was outside the alarm limits or back within range. Note: Although the reading may return to a normal range, an alarm cleared event is not logged if the logger was set up to maintain alarms until reconfigured.
Button Up/Down	The button on the logger was pressed to wake it up/bring it to the top of the loggers list in the app.
New Interval	The logger has switched to logging at the burst logging rate or back to the normal rate.
Power Warn	The battery level dropped below 2.3 V.
Safe Shutdown	The battery level dropped below a safe operating voltage and performed a safe shutdown.

Deploying and Mounting the Logger

When mounting the logger, it is very important that the logger housing does not get distorted. If you are mounting the logger on an irregular surface, it is recommended that you use the included mounting boot (replacements available in 5-packs, PN BOOT-MX2201-2202).

- The logger must be mounted to a flat surface or in such a way that prevents the logger housing from bowing. You can deploy the logger by using the two mounting tabs. Insert two screws through the round holes on the mounting tabs to affix the logger to a flat surface, being careful not to overtighten the screws. Alternatively, you can hang the logger using a loose cable tie loop.



Guidelines for Using the Mounting Boot

- To install the logger in a boot, hold both the boot and the logger upside down and insert the logger mounting tab into the boot as shown.

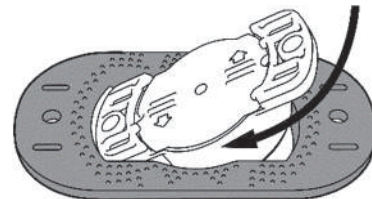

Insert the other logger mounting tab into the boot, making sure the logger is securely seated in the boot as shown.

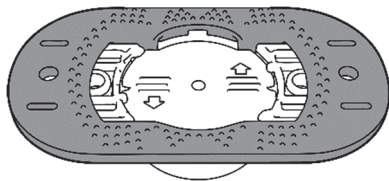

- To mount the logger in a boot to a small pipe, use two of the cable ties included with the boot as shown.

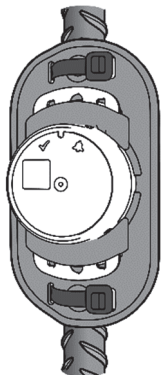

- To mount the logger in a boot to a large pipe, use one of the cable ties included with the boot as shown.

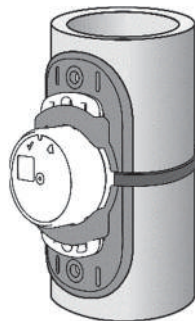

- To mount the logger in a boot to a flat surface, use two #8 screws as shown. Do not overtighten the screws.

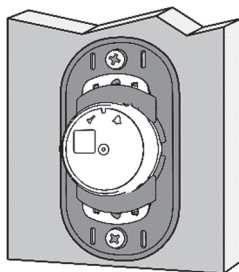

Other Deployment Guidelines

- When deploying in water, the logger should be appropriately weighted, secured, and protected depending on water conditions and desired measurement location.
- Loggers deployed in direct sunlight heat up so that temperature readings are warmer than the ambient temperature. Use a solar radiation shield to ensure temperature readings represent the ambient temperature.

Attach the logger to a solar radiation shield (RS1 or M-RSA) using the solar radiation shield bracket (MX2200-RS-BRACKET). Attach the logger to the underside of the mounting plate as shown in the following example. For more details on the solar radiation shield, refer to the *Solar Radiation Shield Installation Guide* at

www.onsetcomp.com/resources/documentation/4115-man-rs1. **Note:** To log both temperature and sunlight, you need two MX2202 loggers. Place one logger in a solar radiation shield to log temperature and the other mounted flat on top of the solar radiation shield to record sunlight.

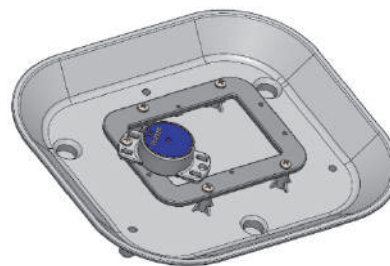

- When measuring light intensity outdoors or underwater, make sure the MX2202 logger is mounted horizontally so that the light sensor is pointing straight up towards the sky as shown in this example.

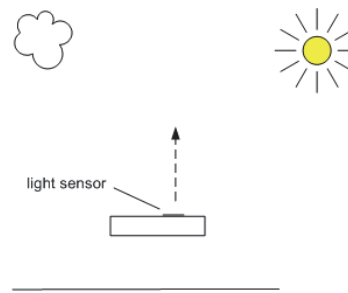

- Be careful of solvents. Check a materials compatibility chart against the wetted materials listed in the Specifications table before deploying the logger in locations where untested solvents are present. The logger has an EPDM O-ring, which is sensitive to polar solvents (acetone, keton) and oils.

Maintaining the Logger

- To clean the logger, rinse it in warm water. Use a mild dishwashing detergent if necessary. Do not use harsh chemicals, solvents, or abrasives.
- Periodically inspect the logger for biofouling if it is deployed in water and clean as described.
- Periodically inspect the O-ring on the inside of the battery cover for cracks or tears and replace it if any are detected (MX2201-02-ORING). See *Battery Information* for steps on replacing the O-ring.

Protecting the Logger

Note: Static electricity may cause the logger to stop logging. The logger has been tested to 8 KV, but avoid electrostatic discharge by grounding yourself to protect the logger. For more information, search for “static discharge” on www.onsetcomp.com.

Battery Information

The logger requires one user-replaceable CR2032 3V lithium battery. Battery life is 1 year typical at 25°C (77°F) with a logging interval of 1 minute and Bluetooth Always On enabled or 2 years typical at 25°C (77°F) when the logger is configured with Bluetooth Always On disabled. Expected battery life varies

based on the ambient temperature where the logger is deployed, the logging interval, the frequency of connections, downloads, and paging, and the use of burst mode or statistics logging. Deployments in extremely cold or hot temperatures or a logging interval faster than one minute can impact battery life. Estimates are not guaranteed due to uncertainties in initial battery conditions and operating environment.

To replace the battery:

1. While pushing down with both thumbs on the back of the logger, rotate the battery cover counterclockwise until it stops moving (about a 1/8 turn).

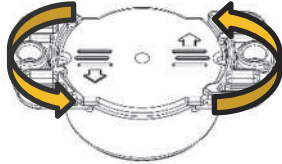

2. Use the edge below the arrow on the cover to lift it off the logger.

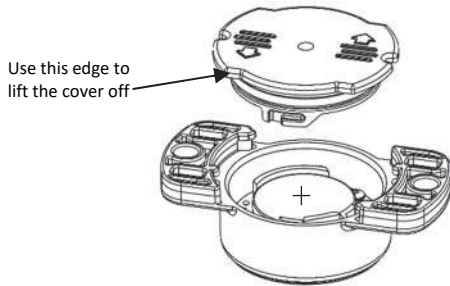

5. Place the cover back on the logger as shown, aligning the notches in the cover with the rounded tabs on the logger case. The cover does not close properly and maintain a waterproof seal if it is misaligned.

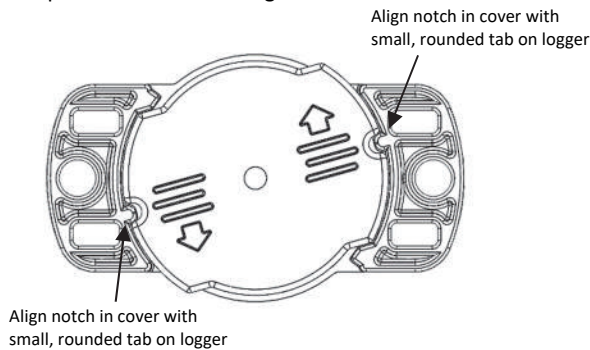

3. Remove the battery and place a new one in the battery holder, positive side facing up. Use a small flat-head screwdriver to carefully pop the battery out of its holder as shown.

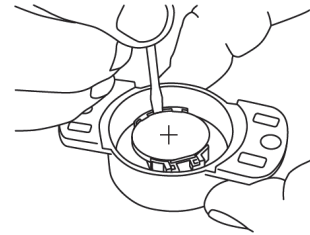

4. Inspect the O-ring on the battery cover. Make sure it is clean and seated properly. Remove any dirt, lint, hair, or debris from the O-ring. If the O-ring has any cracks or tears, replace it as follows:
 - a. Spread a small dot of silicone-based grease on the O-ring with your fingers, making sure the entire O-ring surface is completely covered in grease.
 - b. Place the O-ring on the cover and clean off any debris. Make sure the O-ring is fully seated and level in the groove and not pinched or twisted. This is necessary to maintain a waterproof seal.

6. While pushing down with both thumbs, rotate the battery cover clockwise until it locks in position under the two large corner tabs and the two small rounded tabs.

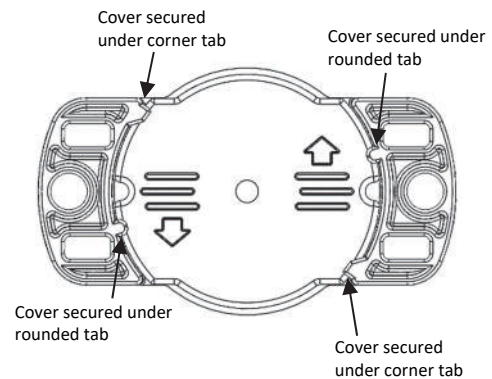

⚠ WARNING: Do not cut open, incinerate, heat above 85°C (185°F), or recharge the lithium battery. The battery may explode if the logger is exposed to extreme heat or conditions that could damage or destroy the battery case. Do not dispose of the logger or battery in fire. Do not expose the contents of the battery to water. Dispose of the battery according to local regulations for lithium batteries.

Federal Communication Commission Interference Statement

This equipment has been tested and found to comply with the limits for a Class B digital device, pursuant to Part 15 of the FCC Rules. These limits are designed to provide reasonable protection against harmful interference in a residential installation. This equipment generates uses and can radiate radio frequency energy and, if not installed and used in accordance with the instructions, may cause harmful interference to radio communications. However, there is no guarantee that interference will not occur in a particular installation. If this equipment does cause harmful interference to radio or television reception, which can be determined by turning the equipment off and on, the user is encouraged to try to correct the interference by one of the following measures:

- Reorient or relocate the receiving antenna
- Increase the separation between the equipment and receiver
- Connect the equipment into an outlet on a circuit different from that to which the receiver is connected
- Consult the dealer or an experienced radio/TV technician for help

This device complies with Part 15 of the FCC Rules. Operation is subject to the following two conditions: (1) This device may not cause harmful interference, and (2) this device must accept any interference received, including interference that may cause undesired operation.

FCC Caution: Any changes or modifications not expressly approved by the party responsible for compliance could void the user's authority to operate this equipment.

Industry Canada Statements

This device complies with Industry Canada license-exempt RSS standard(s). Operation is subject to the following two conditions: (1) this device may not cause interference, and (2) this device must accept any interference, including interference that may cause undesired operation of the device.

Avis de conformité pour l'Industrie Canada

Le présent appareil est conforme aux CNR d'Industrie Canada applicables aux appareils radio exempts de licence. L'exploitation est autorisée aux deux conditions suivantes : (1) l'appareil ne doit pas produire de brouillage, et (2) l'appareil doit accepter tout brouillage radioélectrique subi, même si le brouillage est susceptible d'en compromettre le fonctionnement.

To comply with FCC and Industry Canada RF radiation exposure limits for general population, the logger must be installed to provide a separation distance of at least 20cm from all persons and must not be co-located or operating in conjunction with any other antenna or transmitter.

KC Statement

해당 무선설비는 전파혼신 가능성이 있으므로 인명안전과 관련된 서비스는 할 수 없음

Translation:

The service related to human safety is not allowed because this device may have the possibility of the radio interference.

