

Introduction

What Is a Counter?

A Counter is a device that counts the number of objects or the number of operations. It is called a Counter because it counts the number of ON/OFF signals input from an input device, such as a switch or sensor.

It is fairly simple for people to count ten or twenty objects, but larger numbers make counting increasingly difficult. Counters outperform people when it comes to counting accurately.



The number of steps that someone walks can be automatically and accurately counted according to set rules.

Counter Classifications

Counters are classified into two groups according to whether they produce an output or not.

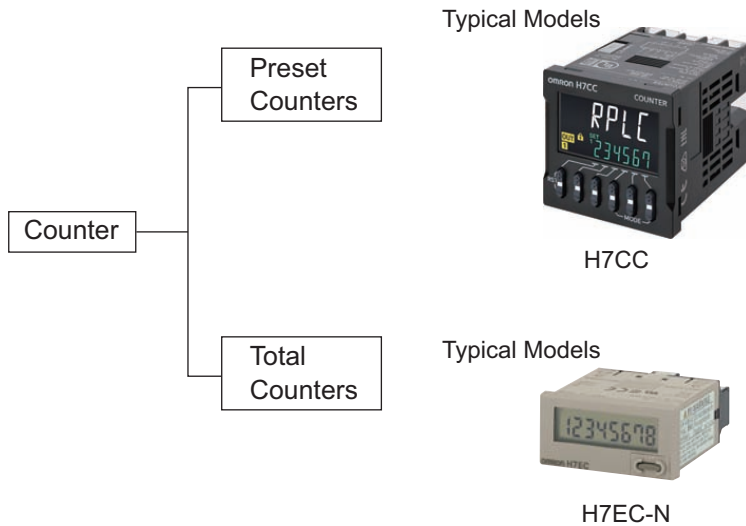

What Is a Preset Counter?

A Preset Counter counts until the present value reaches a preset value, and then it activates a control output to operate an output device.

The term preset in Preset Counter means that you can set a value in advance.

What Is a Total Counter?

A Total Counter does not output a control signal. It only displays the present value.

A Total Counter is often used when you only have to display a production count, for example.

Number of Puddings Counted

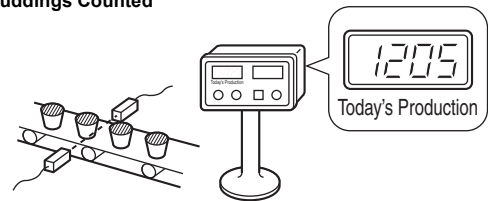

Structure of a Preset Counter

Example: H7CC Digital Counter



1	Display	Displays the count value.
2	Setting Area	Enters settings from the keys on the front panel.
3	Internal Circuits	The internal circuits count the number of input signals, compare the count to the set value, and then output a signal when the two values match.

Operation of a Preset Counter

We will describe the operation of Preset Counters used in automated machinery with a pudding production line. Counters are often mounted on control panels so that the workers can check the display.

Pudding Production Line

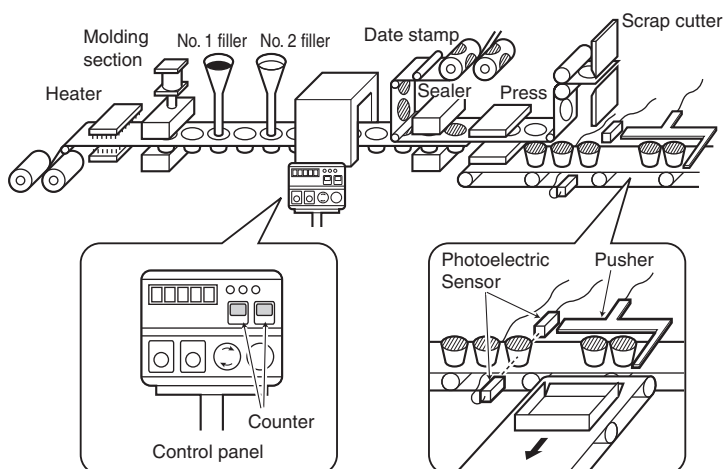

The operation of a Preset Counter is described from signal input to control and signal output in the boxing process of the pudding production line.

(1) Input

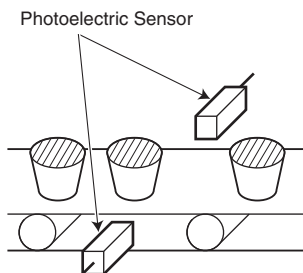

A Photoelectric Sensor is an input device that detects an object when that object blocks light. Each time the light is blocked, the Photoelectric Sensor sends a signal to the Counter.

(3) Output

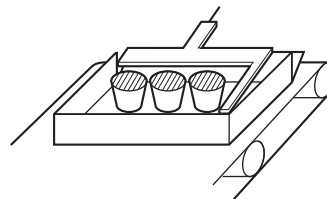

When the Pusher receives the output signal from the Counter, it pushes the three pudding containers into a box.

As you can see, the Counter is involved in every step of the input, control, and output signal sequence.

(2) Control

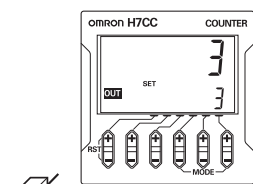

Preset the number three in the Counter. The Counter then counts the number of signals from the Photoelectric Sensor and sends a signal to the Pusher (i.e., the output device) after the Counter receives a signal for the third time.

See the following timing chart for the input and output signal timing in the boxing process for pudding.

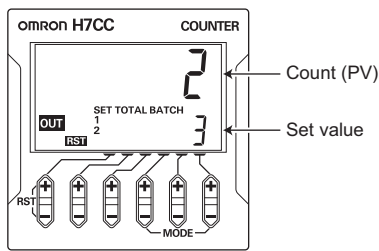

Description of the Timing Chart

- (1) When the first pudding container passes by the Photoelectric Sensor, the Sensor sends a signal to the Counter and 1 is displayed as the count value.
- (2) When the next pudding container passes by the Photoelectric Sensor, 2 is displayed.
- (3) When the third pudding container passes by the Photoelectric Sensor, 3 is displayed. Because this number is the same as the set value, the Counter outputs a signal.

The preset number is called the set value (or preset value). When that number is reached, a signal is output. This is often referred to counting up, but it means the same as timer setting or time up.

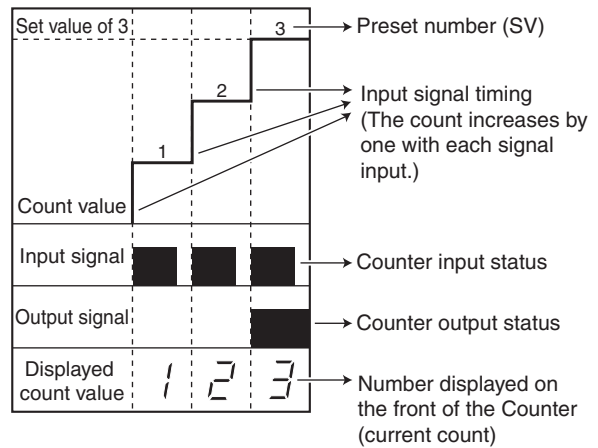

Explanation of Terms

Electronic Counter

A Counter which mainly consists of transistors, ICs, micro-computers, etc.

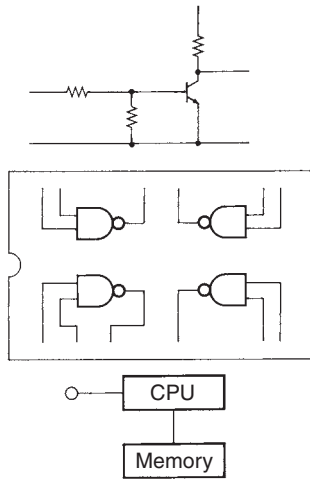

Electromagnetic Counter

A Counter that performs counting by energizing or de-energizing a built-in electromagnet.

Preset Counter

A Counter with a control output that operates when the Counter counts to a set value.

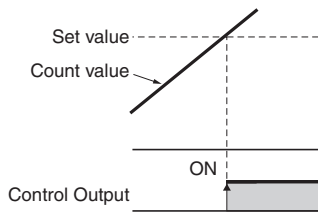

Total Counter

A Counter which indicates the total value of the counting inputs and is not provided with a control output.

Addition (Up/Incrementing) Counter

A Counter having an add input and thus capable of counting in an ascending order.

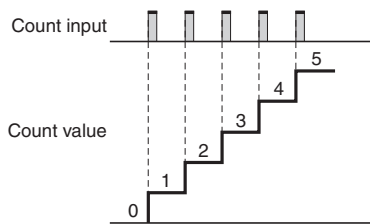

Subtraction (Down/Decrementing) Counter

A Counter with a subtract input and thus capable of counting in descending order.

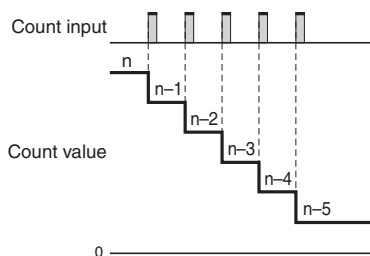

Up/Down Counter

A Counter with the capability of counting in an ascending or descending order, depending on the up-down inputs. Also called a reversible Counter.

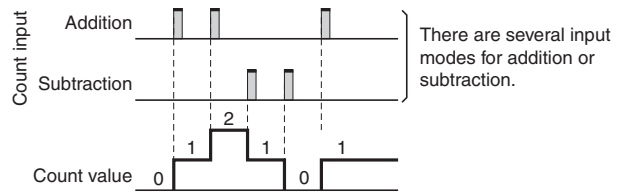

Maximum Counting Speed

The maximum counting speed at which the display and output section of the Counter operates accurately without miscounting. The maximum counting speed is expressed in units of counts per second (cps).

ON/OFF Ratio

The ratio of the ON signal time of a given input signal to the OFF signal time of the same input signal. The maximum counting speed of each Counter is determined by counting an input signal with an ON/OFF ratio of 1:1.

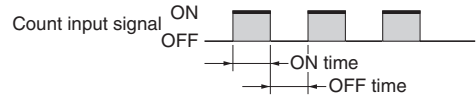

Operating Mode

The control output patterns and display patterns that appear when a Preset Counter counts to the set value.

Examples:

Mode N

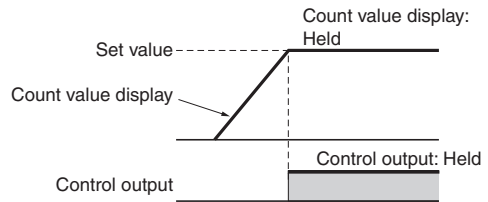

Mode C

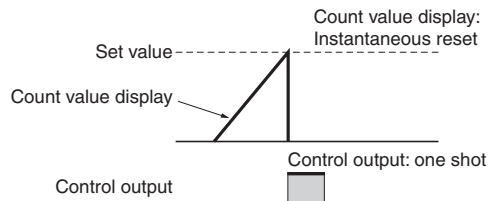

Note: Refer to the datasheets for individual products for information on operation in other modes.

Stage

Number of preset values that correspond with the number of control outputs.

Example: Two-stage Counter

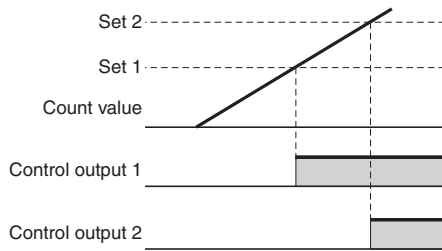

Number of Digits

The maximum number of countable digits.

Display Method

The type of element used to display the counting results.

LED: Light emitting diode

LCD: Liquid crystal display

Note: Electromagnetic Counters display results using a revolving mechanism with printed characters.

Externally Supplied Power

Power that is supplied from the Counter to sensors that are used for counting or resetting. (Also called sensor power.)

Reset

To restore the counting, display and output sections of the Counter, to their initial states.

Power Reset

To reset the Counter by turning OFF the power supply voltage.

External Reset

To reset the Counter by applying a specific signal to the reset input signal terminal.

Auto Reset

To reset the Counter automatically with a signal generated from inside the Counter.

Manual Reset

To mechanically reset the Counter by manual means.

Electromagnetic Reset

To electromagnetically reset the Counter by applying a reset signal.

Counting: Operation Method

Refer to the following timing charts for the input modes of incremental, decrementing, and up/down (or reversible) Counters. (These charts focus on the up/down input mode.)

Up/Down A Command Input

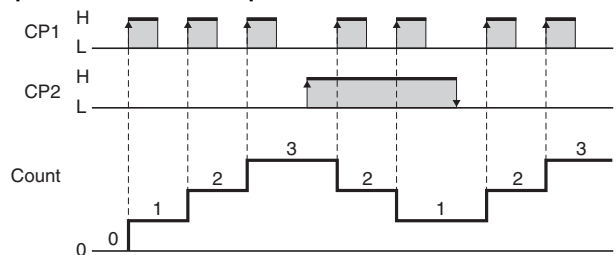

Up/Down B Command Input

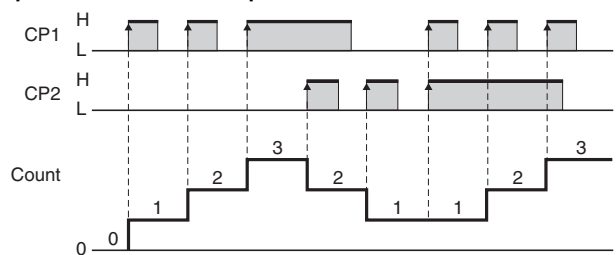

Up/Down C Quadrature Input

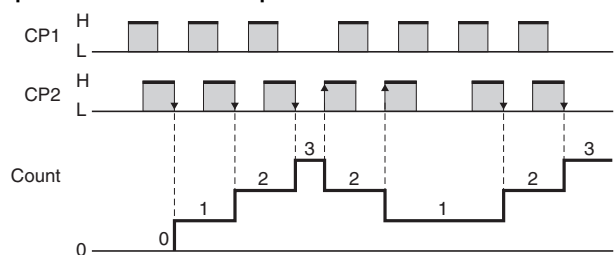

Up/Down D Command Input

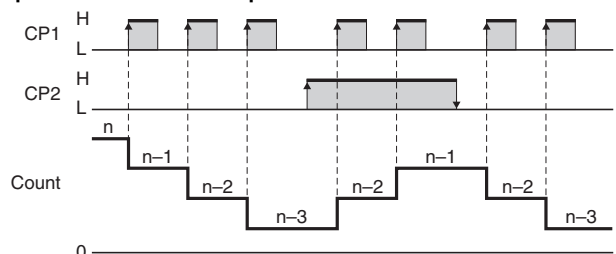

Up/Down E Individual Input

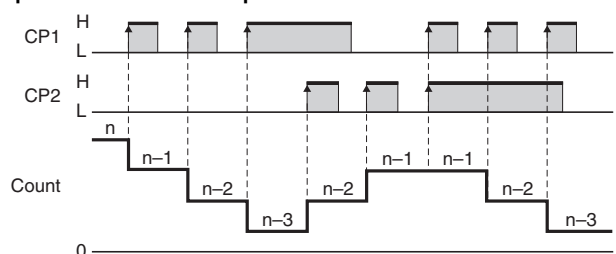

Up/Down F Quadrature Input

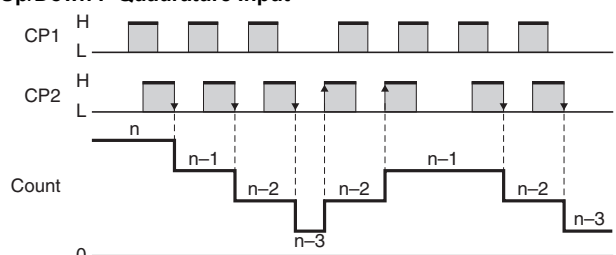

Sensors
Switches
Safety Components
Relays
Control Components
Automation Systems
Motion / Drives
Energy Conservation Support / Environment Measure Equipment
Power Supplies / In Addition
Others
Common

Further Information

Counter Inrush Current (Major Models)

Note: Includes products no longer available to order.

“---” indicates a constant current and therefore the corresponding values are omitted from the table. All the values are approximate values and should therefore only be used as a guide.

Model	Voltage	Applied voltage	Inrush current (peak value)	Time (see note) *
H7AN series	100 to 240 VAC	264 VAC	23 A	1 ms
	12 to 24 VDC	26.4 VDC	15 A	6.5 ms
H7BX series	100 to 240 VAC	264 VAC	7.6 A	2 ms
	24 VAC or 12 to 24 VDC	26.4 VAC	13.5 A	2 ms
H7CN series	100 to 240 VAC	264 VAC	800 mA	1 ms
	12 to 48 VDC	52.8 VDC	400 mA	1 ms
H7E series	---	---	---	---
H7CX-A□-N series	100 to 240 VAC	264 VAC	4.9 A	0.9 ms
	24 VAC or 12 to 24 VDC	26.4 VAC	9.3 A	1.4 ms
H7CX-A□D-N series		24 VAC or 12 to 24 VDC	26.4 VDC	6.2 A
	26.4 VAC		9.2 A	1 ms
H7CX-A series (previous models)	24 VAC or 12 to 24 VDC	26.4 VDC	6.3 A	1 ms
		100 to 240 VAC	264 VAC	5.8 A
H7CX-R series (previous models)	100 to 240 VAC	264 VAC	5.8 A	0.7 ms
	24 VAC or 12 to 24 VDC	26.4 VAC	10.4 A	1.2 ms
	12 to 24 VDC	26.4 VDC	6 A	1.2 ms
H7CZ series	100 to 240 VAC	264 VAC	4.6 A	0.4 ms
	24 VAC or 12 to 24 VDC	26.4 VAC	9.2 A	1 ms
H8BM-R series		DC24V	26.4 VDC	6.3 A
	26.4 VDC		1.6 A	12 ms

* The time of the inrush current is measured in the range shown in the following waveform.

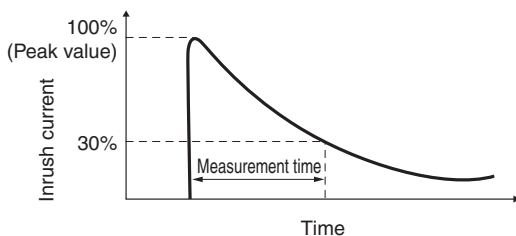

Operation When Counter Set Value Is 0

Model	Operation
H7AN H7CN	Instantaneous output when power is turned ON. Output OFF during reset input.
H7BX H7CX	In output mode N or F, instantaneous output when power supply is turned ON and turns OFF during the reset input. In any other mode, instantaneous output turns and then turns OFF after the one-shot time has elapsed. In mode K-1, output turns OFF after the one-shot time for output 2 has elapsed even if output 1 is set to be self-holding.

What Is a Time Counter?

A Time Counter counts time and displays the length of time that has been counted. Time Counters are also called Total Time Meters or Hour Meters. Hours is not the only unit available, and time can be displayed in minutes, seconds, or in some cases even days. A Time Counter is not a Timer. You set a specific time with a Timer and an electrical signal is output when that time has elapsed. With a Time Counter, you do not set a time. It simply totals the time and displays that total. If you were to define the two in terms of Timers, then a Timer would be a Preset Timer and a Timer Counter would be a Total Timer. The Time Counter, however, has historically been classified as a Counter.