

Introduction

What Is a Servomotor and What Is a Servo Drive?

A servomotor is a structural unit of a servo system and is used with a servo drive. The servomotor includes the motor that drives the load and a position detection component, such as an encoder.

The servo system vary the controlled amount, such as position, speed, or torque, according to the set target value (command value) to precisely control the machine operation.

Servo System Configuration Example

(1) Command section

Outputs command signals for operation.



Controller

Target values



Feedback signals



(2) Control section

Controls the motor according to commands.



Servo drive

Motor power signals



Feedback signals



(3) Drive and detection section

Drives the controlled object and detects that object.

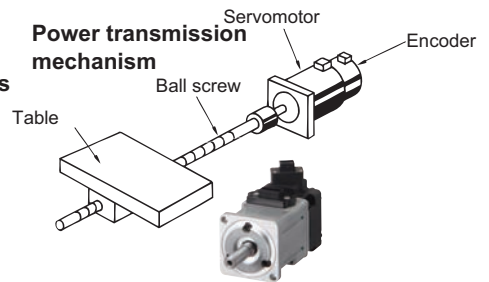

Servomotor

Features

Precise, High-speed Control

- Servomotors excel at position and speed control.
- Precise and flexible positioning is possible.
- Servomotors do not stall even at high speeds. Deviations due to large external forces are corrected because encoders are used to monitor movement.

Fully-closed Loop

The most reliable form of closed loop. A fully-closed loop is used when high precision is required.

The motor is controlled while directly reading the position of the machine (workpiece or table) using a linear encoder and comparing the read position with the command value (target value). Therefore, there is no need to compensate for gear backlash between the motor and mechanical system, feed screw pitch error, or error due to feed screw torsion or expansion.

Fully-closed Loop System Configuration Example

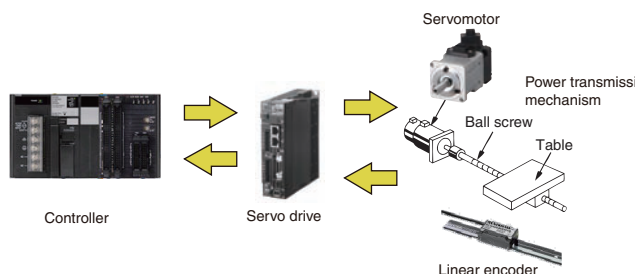

Semi-closed Loop

This method is commonly used in servo systems. It is faster and has better positioning precision than an open loop. Typically an encoder or other detector is attached behind the motor. The encoder detects the rotation angle of a feed screw (ball screw) and provides it as feedback of the machine (workpiece or table) travel position. This means that the position of the machine is not detected directly. The characteristics depend on where the detector is installed.

Installation location of detector	Behind motor	Motor side of feed screw	Opposite of motor side of feed screw
Gear backlash	Compensation required	Compensation not required	←
Ball screw or nut torsion	Affected	←	Hardly affected
Ball screw expansion or contraction	Affected	←	←
Ball screw pitch error	Compensation required	←	←

Semi-closed Loop System Configuration Example

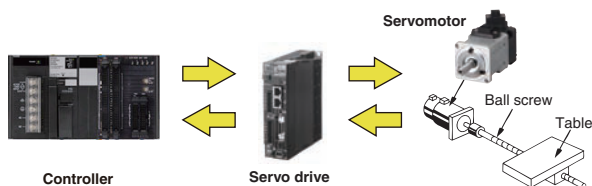

Open Loop

A stepper motor is used instead of a servomotor. There is no feedback loop.

The overall configuration is simple. Positioning can be performed at low cost, but gear and ball screw backlash and pitch errors cannot be compensated. When a stepper motor stalls, an error will occur between the command value and the actual movement. This error cannot be compensated. Open loop control is suitable for low-precision, low-cost, low-speed, and low-load-change applications.

Open Loop System Configuration Example

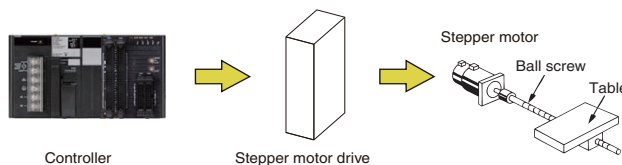

Sensors

Switches

Safety Components

Relays

Control Components

Automation Systems

Motion / Drives

Energy Conservation Support / Environment Measure Equipment

Power Supplies / In Addition

Others

Common

Principles

Servo Operation and Configuration

A system built with servo drives and servomotors controls motor operation in closed loop. The actual position, speed, or torque of the servomotor is fed back to compare to the command value and calculate the following errors between them. Then the servo drive corrects the operation of the servomotor in realtime using this error information to ensure that the system can achieve the required performance. This cycle of feedback, error detection, and correction is called closed-loop control.

The control loop is processed by either of servo drive or motion controller, or both depending on the required control. The control loops for position, speed, and torque are independently used to achieve the required operation. Applications will not always require all three control loops. In some applications, only the control loop for torque control will be required. In other applications, current and speed for speed control are required, and in still other applications, three control loops for position control are required.

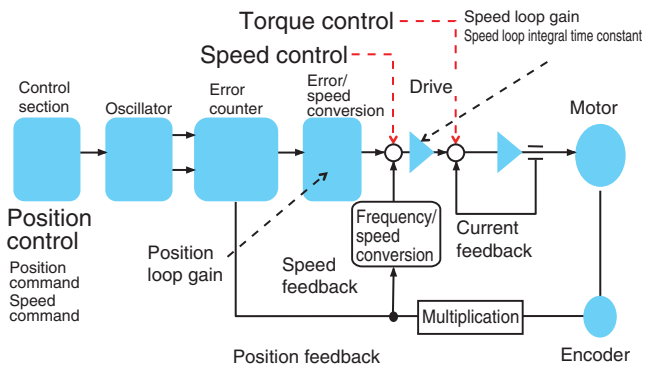

Servomotor

The most common types of industrial servomotors are those based on brushless motors. The rotor has a powerful permanent magnet. The stator is composed of multiple conductor coils, and the rotor spins when the coils are powered in the specified order. The movement of the rotor is determined by the stator's frequency, phase, polarity, and current when the correct current is supplied to the stator coils at the appropriate time.

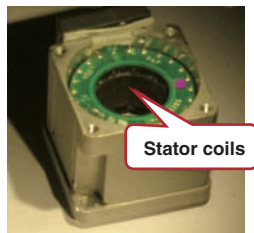
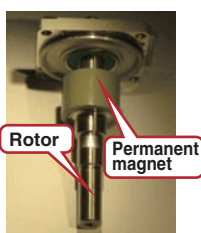
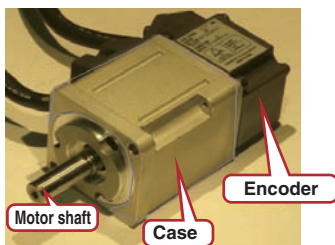

Encoder

Servomotors are different from typical motors in that they have encoders. This allows high-speed and high-precision control according to the given position and speed commands. Encoders are one of the hardware elements that form the core of a servo system, and they generate speed and position feedback. In many cases, the encoder is built into the servomotor or attached to the servomotor. In certain applications, the encoder is an independent unit that is installed away from the servomotor. When the encoder is installed in a remote location, it is used for related parameters in addition to for control of servomotor operation.

Encoders are divided into two kinds.

- Incremental encoders
- Absolute encoders

Multi-turn absolute encoders are typically used for servomotors.

Refer to the *Technical Explanation for Rotary Encoders* for more information on encoders.

Servo Drive

Servo drives follow commands from the host controller and control the output torque, rotation speed, or position of motors.

The position, speed, or torque are controlled according to inputs from a motion controller, feedback encoder, and the servomotor itself, and the servo drive supplies the appropriate amounts of power to the servomotor at the appropriate times.

The basic operating principle is the same as for an inverter, in which the motor is operated by converting AC power to DC power to be a certain frequency.

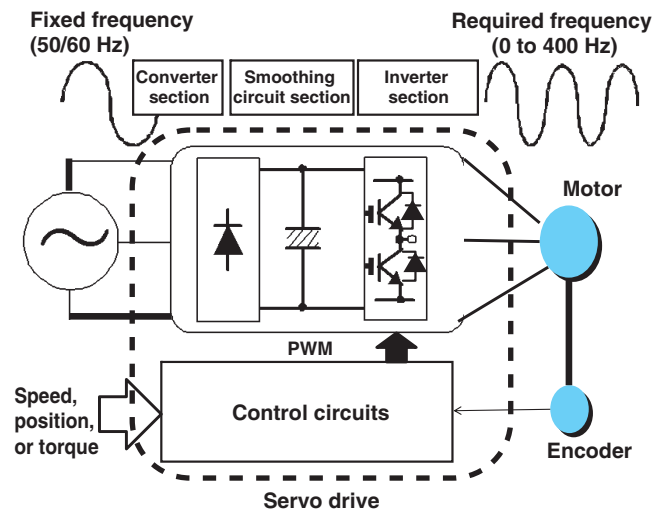

A servo drive also has the following functions.

- Communications with the motion controller
- Encoder feedback reading and realtime closed-loop control adjustment
- I/O processing for safety components, mode inputs, and operating status output signals

Explanation of Terms

Performance

Effective Torque

A value of the average torque (RMS) that is produced during operation of a motor.

A motor with a larger value than the effective torque must be chosen.

The unit is N·m.

Torque Constant

When a current flows to a motor, the current and the flux produce a torque.

The torque constant is the relationship between this current and the produced torque. The higher the torque, the smaller the controlling current.

The unit is N·m/A.

Power Rate

The power rate is given by this formula:

Power rate = (Rated torque)²/Rotor inertia x 10⁻³.

The higher the value is, the better the response is.

The unit is kW/s.

Rotor Inertia

The moment of inertia of the rotor, expressed in Jm.

The smaller the value is, the quicker the response is.

The unit is kg·m².

Applicable Load Inertia

The range in which a drive can control the load inertia.

The range is limited by the gain adjustment range and the energy absorption capacity. The unit is kg·m².

Rated Output

The rated output (P) is the mechanical power that a motor can output.

The rated torque (T) and the rated speed (N) are related to the rated power as follows:

$P=0.105 \times T \times N$

Electrical Time Constant

The transient response time to the current that flows to the armature of a motor to which a power supply voltage is applied.

It is expressed by this formula: Electrical time constant = Armature inductance/Armature resistance.

Because a smaller value enables the current wave to rise more quickly, the transient response time to the current is faster.

Backlash

The mechanical system has a dead zone between forward and reverse.

A gear that changes from forward to reverse must turn by the amount of the dead zone before turning the specified amount.

This movement is called the backlash.

Backlash is given in minutes. One turn is 360 degrees. One minute is 1/60 of 1 degree.

The smaller the backlash is, the less the dead zone is.

Regeneration Resistance

A resistor that absorbs regenerative energy. Regenerative energy is the energy generated by a motor when the motor operates.

A servo drive uses internal regenerative processing circuits to absorb the regenerative energy generated by a motor when the motor decelerates to prevent the DC voltage from increasing.

If the regenerative energy from the motor is too large, an overvoltage can occur.

To prevent overvoltages, the operation pattern must be changed to reduce the regenerative energy or an external regenerative resistor must be connected to increase the capacity to process regenerative energy.

Vibration Class

A class based on the value of the vibration measured at the shaft of a motor rotating at the rated speed without a load.

There are five vibration classes into which the measured total amplitudes are divided.

Position Control Mode

A control mode in which positioning commands are input from a controller and positioning is controlled using the target values in the commands.

Closed Loop

A control method that compares the position commanded by the controller and the actual motor position.

An error signal is returned to the controller and used to give the system the correct position.

Closed-loop control can be performed based on the speed, acceleration, or torque in addition to the position.

The motion control method without using feedback is called open loop.

Open Loop

A control method in which the results of movement are not compared with the actuator reference.

When the controller commands the motor to move, it is assumed that the requested movement will be completed.

Control Loop

In process control, a control loop adjusts a target variable by adjusting other variables using feedback and error correction.

In motion control, control loops are set for speed, acceleration, position, or torque.

Functions

Realtime Autotuning

Realtime autotuning estimates the load inertia of the machine in realtime, and operates the machine by automatically setting the gain according to the estimated load inertia.

At the same time, it can lower the resonance and vibration if the adaptive filter is enabled.

Manual Tuning

A gain adjustment method used when autotuning cannot be performed due to the restrictions of the operating pattern or load conditions or when maximum responsiveness needs to be obtained for individual loads.

Notch Filter

A notch filter is used to eliminate a specified frequency component.

The notch filter can restrict a resonance peak, and it allows a high gain setting and vibration reduction.

Disturbance Observer Function

The effect of disturbance torque can be lowered, and vibration can be reduced by using the disturbance torque value.

Friction Torque Compensation Function

A function that reduces the influence of mechanical friction.

Hybrid Vibration Suppression Function

A function that suppresses the vibration that is caused by the amount of the torsion between the motor and the load.

Feed-forward Function

A function that increases the responsiveness of the control system by adding the feed-forward value to the command value.

Instantaneous Speed Observer Function

This function uses a load model to estimate the motor speed. It improves the speed detection accuracy and can provide both high responsiveness and minimum vibration when stopping.

Safe Torque OFF Function

The safe torque OFF function (STO) is used to cut off the motor current and stop the motor through the input signals from a safety device, such as a safety controller or safety sensor.

Regenerative Energy Absorption

A servo drive absorbs regenerative energy internally with the built-in capacitor.

If the regenerative energy cannot be completely absorbed with the built-in capacitor, it is absorbed with the internal regeneration resistor.

Regenerative Energy

Power produced by a motor for a generator.

The regenerative energy is produced by the external forces or gravity during Servomotor deceleration.

In this case, measures for design must be taken to keep the energy within the energy absorption capacity.

Forward and Reverse Drive Prohibit

A function that prevents the servomotor from rotating outside of the operating range of the device by connecting limit inputs. When the Forward Drive Prohibit Input or Reverse Drive Prohibit Input turns OFF, the Servomotor will stop rotating.

Damping Control

A function used to reduce vibration when using a low-rigidity mechanism or equipment whose ends tend to vibrate.

Internally Set Speed Control

A function that controls the speed of the servomotor using speeds set in the internal speed setting parameters.

Electronic Gear

A function that rotates the servomotor for the number of pulses obtained by multiplying the command pulses by the electronic gear ratio.

The electronic gear is used to synchronize the position and speed of two lines, to enable using a position controller with a low command pulse frequency or to set the machine travel distance per pulse, to 0.01 mm for example.

Torque Limit

A function that limits the output torque of a motor.

The torque limit is used for pressing a moving part of a machine (such as a bending machine) against a workpiece with a constant force, or for protecting the servomotor and mechanical system from excessive force or torque.

Position Command Filter

A function that performs soft start processing for the command pulses using the selected filter to gently accelerate and decelerate.

The filter characteristics for the position command filter are selected using the Position Command Filter Time Constant Setting.

This function is effective when there is no acceleration or deceleration function in the command pulse (controller), when the command pulse frequency changes abruptly, causing the machinery to vibrate during acceleration and deceleration, or when the electronic gear setting is high.

Position Loop Gain

Servo systems with a low loop gain have a low response and can increase the positioning time.

The higher the position loop gain, the shorter the positioning time. If the setting is too high, however, overshooting or hunting may occur in the system.

Incremental Command

An incremental command determines the travel amount between the present position and the target position.

Absolute Command

An absolute command determines the travel amount from a command value that is based upon the origin.

Thus the command value is different from the travel amount unless the motor is at the origin.

Error Counter

An up/down binary counter that counts the difference between the position command pulses and the position feedback pulses. is converted by an D/A (digital/analog) converter and becomes the speed command voltage.

The accumulated pulses is converted to an analog voltage by an D/A (digital/analog) converter and becomes the speed command voltage.

Absolute Position

Position information that fully describes a position within a space without referencing a previous position.

Absolute Positioning

Directly moving devices or materials to a specific position in a space without referencing the previous position.

Positioning Completion Signal

A signal that occurs when positioning is completed.

This signal turns ON when the following error is within the in-position range set in the parameter.

This signal is primarily used to start any of the following operations after positioning.

This signal is also called the in-position signal (INP).

Motor with Brake

A motor with an electromagnetic brake.

Brake Interlock

A function that sets the output timing for the brake interlock output (BKIR) signal that activates the holding brake when the servo is turned ON, when an alarm occurs, or when the servo is turned OFF.

The output timing is set in the parameter when a motor with a brake is used.

A holding brake is used in applications, such as for a vertical axis, to prevent the workpiece from falling.

Dynamic Brake (DB)

A brake that converts the rotational energy into heat by short-circuiting the terminals of the servomotor through a resistor to quickly stop the motor when a power is interrupted or a servo amplifier failure occurs.

Larger brake torque can be obtained than with an electromagnetic brake.

However, there is no holding torque when the motor is stopped, so a mechanical brake must be applied to hold the motor.

Dynamic brake is used for mechanical protection.

Free Run

A status in which a motor continues to rotate due to its inertia when servo is turned OFF.

Immediate Stop Torque

When an error is detected, the motor is stopped with the torque set in the parameter.

Others

Servomotor with Absolute Encoder

A servomotor with an absolute encoder has an encoder in which a disk rotates to tell the servomotor the position when the power is turned ON.

A servomotor with absolute encoder that is used in an industrial robot or multi-axis transfer system needs to know the position when the power is turned ON to continue operation quickly after a power interruption or to prevent mistakes in operation.

A servomotor with an absolute encoder needs a backup battery for operation.

Servomotor with Incremental Encoder

A servomotor with an incremental encoder does not know the position when the power is turned ON.

Instead, it needs to perform an origin search to enable positioning.

Encoder Dividing

A function that sets the number of pulses for the encoder signals output from the servo drive.

Encoder dividing is used for a controller with a low response frequency or for setting a pulse rate that is easily divisible.

Servomotor

A device that is a structural unit of a servo system and is used with a servo drive.

The servomotor includes the motor that drives the load and a position detection component, such as an encoder.

Servo Drive

A device that is a structural unit of a servo system and is used with a servomotor.

The servo drive controls the servomotor according to instructions from a PLC or other controller and performs feedback control with signals from an encoder or other component.

Decelerator

A power transmission mechanism that decreases motor speed and increases torque.

If the reduction ratio is $1/R$ and the decelerator efficiency is η , the speed will be $1/R$, the torque $R \times \eta$, and the load inertia $1/R^2$.

Winding Resistance

The line resistance of a coil.

Actuator

A device that generates mechanical motion using air pressure, water pressure, or electricity.

Industrial actuators are commonly driven by electric motors.

Ball Screw

One of the lead screws.

The threads of the screw are pulled with ball bearings in a carriage.

Its high mechanical efficiency and low energy consumption result in high rigidity and high reliability.

Ball screws are mainly used in high-speed and high-precision machines.

Rack and Pinion

A device that converts rotary motion into linear motion. Normally a rack and pinion is composed of a gearwheel (pinion) and a flat toothed bar (rack).

Shaft Bearing

A part that supports a shaft that rotates or performs reciprocating operation.

Coupling

A part that is used to connect shafts together.

Timing Belt

A power transmission mechanism that converts rotary motion into linear motion in conjunction with pulleys.

If the pulley diameter is D , the travel distance per rotation is πD .

Timing belts are usually toothed belts that mesh with pulleys to prevent slipping.

Pulley

A rotary part that transmits rotary motion to a belt.

Bearing

A machine part that fits between stationary parts and rotating parts to support the rotating parts

Synchronous Motor and Induction Motor

Synchronous Motor:

A motor that has magnetic poles in the motor rotor and moves synchronously with the behavior of the magnetic field.

Induction Motor:

A motor whose movement is delayed in respect to the behavior of the magnetic field.

The rotor is constructed of a non-magnetic material, such as aluminum or copper. A magnetic field created in the stator induces a current in the rotor. Rotation of the rotor results from the interaction of the magnetic field created by the rotor current with the magnetic field of the stator.

Stiffness

The property of an object to retain its original shape when an external force is applied.

The higher the stiffness, the higher the ability of an object to retain its original shape.

The lower the stiffness, the more easily an object is stretched or compressed by an external force.

Inertia

The property of an object to maintain its current state of motion.

Inertia is dependent on an object's mass, shape, and axis of movement.

Further Information

Servomotor Selection Flow Chart

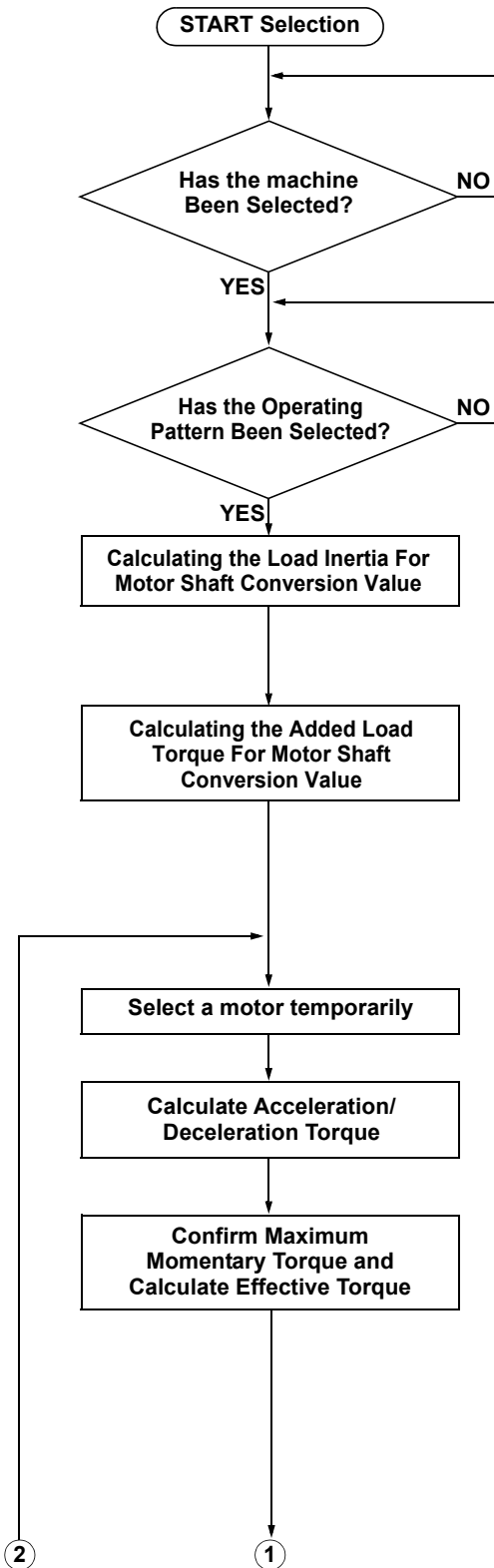

Explanation	References
<ul style="list-style-type: none"> Determine the size, mass, coefficient of friction, and external forces of all the moving part of the servomotor the rotation of which affects. 	---
<ul style="list-style-type: none"> Determine the operating pattern (relationship between time and speed) of each part that must be controlled. Convert the operating pattern of each controlled element into the motor shaft operating pattern. 	<ul style="list-style-type: none"> Operation Pattern Formula
<ul style="list-style-type: none"> The elements of the machine can be separated so that inertia can be calculated for each part that moves as the servomotor rotates. Calculate the inertia applied to each element to calculate the total load inertia of the motor shaft conversion value. 	<ul style="list-style-type: none"> Inertia Formulas
<ul style="list-style-type: none"> Calculation of Friction Torque Calculates the frictional force for each element, where necessary, and converts it to friction torque for a motor shaft. Calculation of External Torque Calculates the external force for each element, where necessary, and converts it to external torque of a motor shaft. Calculates the total load torque for the motor shaft conversion value. 	<ul style="list-style-type: none"> Load Torque Formulas
<ul style="list-style-type: none"> Select a motor temporarily based upon the motor shaft converted load inertia, friction torque, external torque and r.p.m of a motor. 	---
<ul style="list-style-type: none"> Calculate the Acceleration/Deceleration Torque from the Load Inertia or Operating Pattern. 	<ul style="list-style-type: none"> Acceleration/Deceleration Torque Formulas
<ul style="list-style-type: none"> Calculate the necessary torque for each part of the Operating Pattern from the Friction Torque, External Torque and Acceleration/Deceleration Torque. Confirm that the maximum value for the Torque for each operating part (Maximum Momentary Torque) is less than the Maximum Momentary Torque of the motor. Calculate the Effective Torque from the Torque for each Operating part, and confirm that it is less than the Rated Torque for the motor. 	<ul style="list-style-type: none"> Calculation of Maximum Momentary Torque, Effective Torque

Sensors

Switches

Safety Components

Relays

Control Components

Automation Systems

Motion / Drives

Energy Conservation Support / Environment Measure Equipment

Power Supplies / In Addition

Others

Common

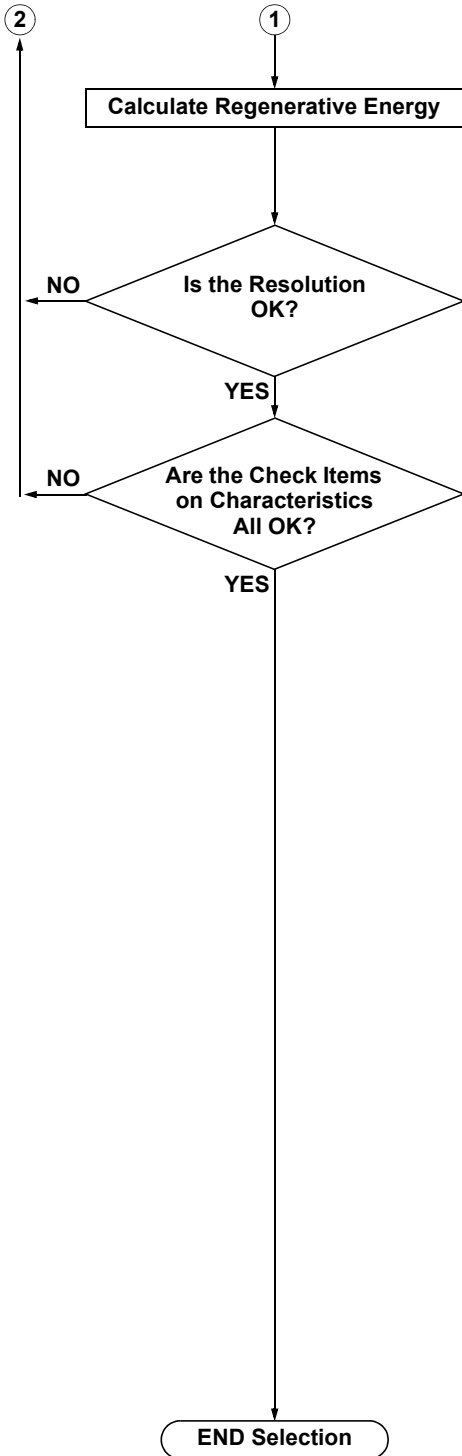

Explanation	References
<ul style="list-style-type: none"> Calculate Regenerative Energy from the Torque of all the moving parts. 	<ul style="list-style-type: none"> Please see the user manual of each product for the details on calculation of the regenerative energy.
<ul style="list-style-type: none"> Check if the the number of encoder pulses meets the system specified resolution. 	<ul style="list-style-type: none"> Accuracy of Positioning
<ul style="list-style-type: none"> Check if the calculation meets the specifications of the temporarily selected motor. If not, change the temporarily selected motor and re-calculate it. 	<ul style="list-style-type: none"> The following table

Specialized Check Items	Check Items
Load Inertia	Load Inertia ≤ Motor Rotor Inertia x Applicable Inertia Ratio
Effective Torque	Effective Torque < Motor Rated Torque • Please allow a margin of about 20%. *
Maximum Momentary Torque	Maximum Momentary Torque < Motor Maximum Momentary Torque • Please allow a margin of about 20%. * • For the motor Maximum Momentary Torque, use the value that is combined with a driver and the one of the motor itself.
Maximum Rotation Speed	Maximum Rotation Speed ≤ Rated Rotation Speed of a motor • Try to get as close to the motor's rated rotations as possible. It will increase the operating efficiency of a motor. • For the formula, please see " Straight-line Speed and Motor Rotation Speed " on Page 16.
Regenerative Energy	Regenerative Energy ≤ Regenerative Energy Absorption of a motor • When the Regenerative Energy is large, connect a Regenerative Energy Absorption Resistance to increase the Absorption capacity of the driver.
Encoder Resolution	Ensure that the Encoder Resolution meets the system specifications.
Characteristics of a Positioner	Check if the Pulse Frequency does not exceed the Maximum Response Frequency or Maximum Command Frequency of a Positioner.
Operating Conditions	Ensure that values of the ambient operating temperature/humidity, operating atmosphere, shock and vibrations meet the product specifications.

* When handling vertical loads and a load affected by the external torque, allow for about 30% of capacity.

Formulas

Formulas for Operating Patterns

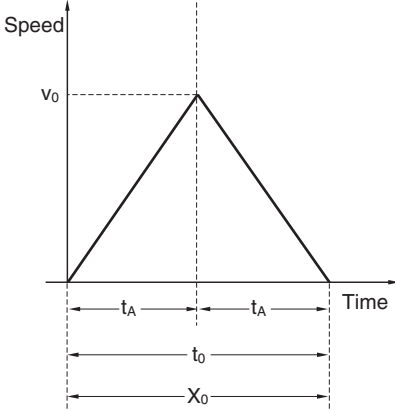
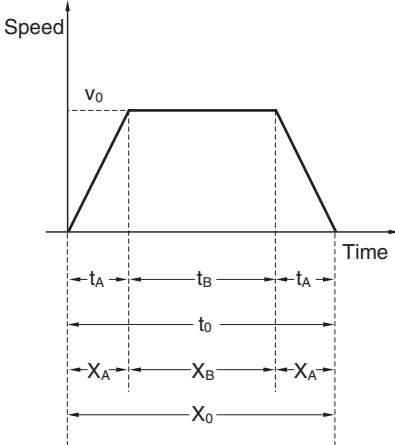
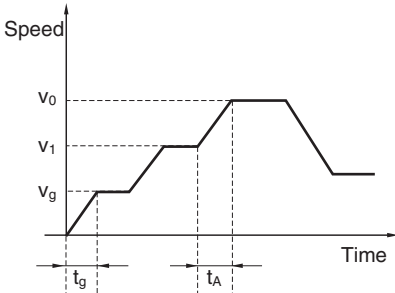
<p>Triangular</p>		<p>Maximum Speed $v_0 = \frac{X_0}{t_A}$ X_0: Distance Moved in t_0 Time [mm] v_0: Maximum Speed [mm/s]</p> <p>Acceleration/Deceleration Time $t_A = \frac{X_0}{v_0}$ t_0: Positioning Time [s] t_A: Acceleration/Deceleration Time [s]</p> <p>Travel Distance $X_0 = v_0 \cdot t_A$</p>
<p>Trapezoid</p>		<p>Maximum Speed $v_0 = \frac{X_0}{t_0 - t_A}$</p> <p>Acceleration/Deceleration Time $t_A = t_0 - \frac{X_0}{v_0}$</p> <p>Total Travel Time $t_0 = t_A + \frac{X_0}{v_0}$</p> <p>Constant-velocity travel time $t_B = t_0 - 2 \cdot t_A = \frac{2 \cdot X_0}{v_0} - t_0 = \frac{X_0}{v_0} - t_A$</p> <p>Total Travel Distance $X_0 = v_0 (t_0 - t_A)$</p> <p>Acceleration/Deceleration Travel Distance $X_A = \frac{v_0 \cdot t_A}{2} = \frac{v_0 \cdot t_0 - X_0}{2}$</p> <p>Constant-velocity travel distance $X_B = v_0 \cdot t_B = 2 \cdot X_0 - v_0 \cdot t_0$</p>
<p>Speed and Slope When Ascending</p>	 <p>Speed Gradient $\alpha = \frac{v_g}{t_g}$</p>	<p>Ascending Time $t_A = \frac{v_0 - v_1}{\alpha}$</p> <p>Ascending Time (tA) including distance moved</p> $X_A = \frac{1}{2} \alpha \cdot t_A^2 + v_1 \cdot t_A$ $= \frac{1}{2} \frac{(v_0 - v_1)^2}{\alpha} + v_1 \cdot t_A$ <p>Speed after Ascending $v_0 = v_1 + \alpha \cdot t_A$</p>

Sensors

Switches

Safety Components

Relays

Control Components

Automation Systems

Motion / Drives

Energy Conservation Support / Environment Measure Equipment

Power Supplies / In Addition

Others

Common

Speed and Slope Trapezoid pattern

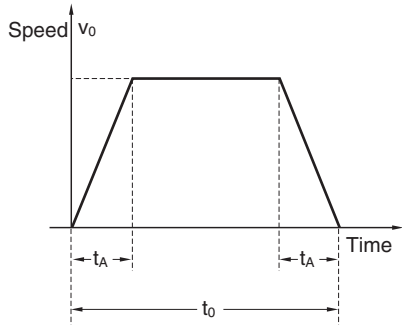

Conditions for Trapezoidal Operating Pattern

$$X_0 < \frac{t_0^2 \cdot \alpha}{4}$$

Maximum Speed

$$v_0 = \frac{t_0 \cdot \alpha}{2} \left(1 - \sqrt{1 - \frac{4X_0}{t_0 \cdot \alpha}}\right)$$

Ascending Time

$$t_A = \frac{v_0}{\alpha} = \frac{t_0}{2} \left(1 - \sqrt{1 - \frac{4X_0}{t_0 \cdot \alpha}}\right)$$

X_0 : Positioning Distance [mm]
 t_0 : Positioning Time [s]
 t_A : Acceleration/Deceleration Time [s]
 v_0 : Maximum Speed [mm/s]
 α : Speed Gradient

Speed and Slope Triangular Pattern

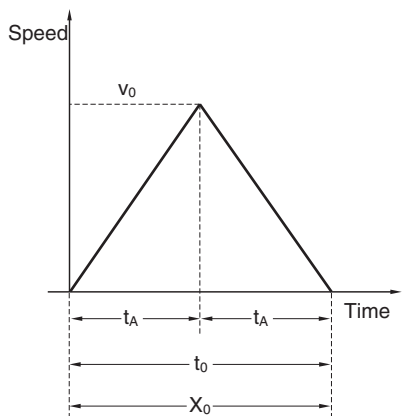

Conditions for Triangular Operating Pattern

$$X_0 \geq \frac{t_0^2 \cdot \alpha}{4}$$

Maximum Speed

$$v_0 = \sqrt{\alpha \cdot X_0}$$

Ascending Time

$$t_A = \sqrt{\frac{X_0}{\alpha}}$$

Rotating Part

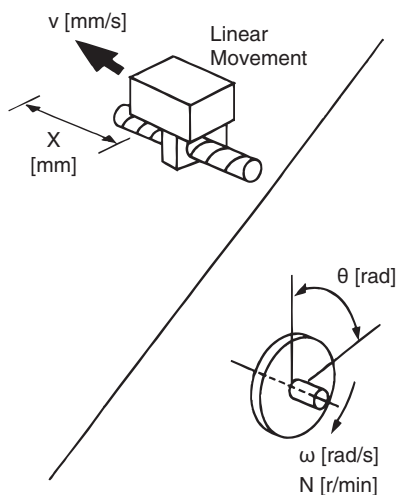

Perform the following unitary conversions

Linear Movement	Rotating Movement
X: Distance [mm]	θ : Angle [rad]
v: Speed [mm/s]	ω : Angular Velocity [rad/s]

$$\left(\omega = \frac{2\pi \cdot N}{60} \right)$$

(N: Rotating Speed [r/min])

Inertia Formulas

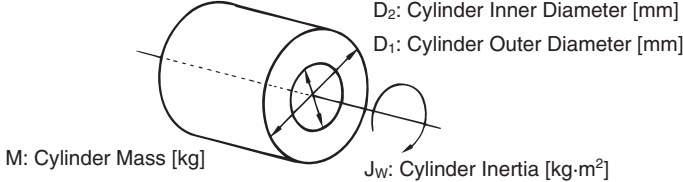
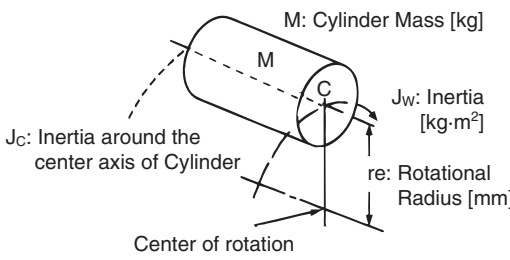
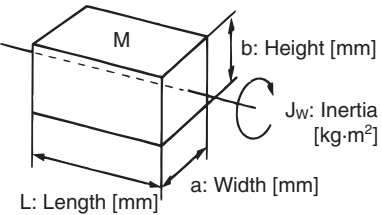
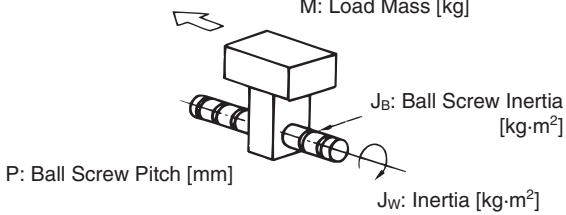
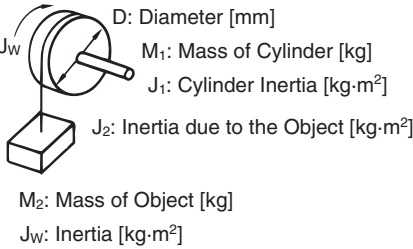
<p>Cylindrical Inertia</p>	 <p> D_2: Cylinder Inner Diameter [mm] D_1: Cylinder Outer Diameter [mm] M: Cylinder Mass [kg] J_w: Cylinder Inertia [kg·m²] </p>	$J_w = \frac{M(D_1^2 + D_2^2)}{8} \times 10^{-6} \text{ [kg·m}^2\text{]}$
<p>Eccentric Disc Inertia (Cylinder which rotates off the center axis)</p>	 <p> M: Cylinder Mass [kg] J_c: Inertia around the center axis of Cylinder J_w: Inertia [kg·m²] r_e: Rotational Radius [mm] Center of rotation </p>	$J_w = J_c + M \cdot r_e^2 \times 10^{-6} \text{ [kg·m}^2\text{]}$
<p>Inertia of Rotating Square Cylinder</p>	 <p> M: Square Cylinder Mass [kg] J_w: Inertia [kg·m²] L: Length [mm] a: Width [mm] b: Height [mm] </p>	$J_w = \frac{M(a^2 + b^2)}{12} \times 10^{-6} \text{ [kg·m}^2\text{]}$
<p>Inertia of Linear Movement</p>	 <p> M: Load Mass [kg] J_b: Ball Screw Inertia [kg·m²] P: Ball Screw Pitch [mm] J_w: Inertia [kg·m²] </p>	$J_w = M \left(\frac{P}{2\pi} \right)^2 \times 10^{-6} + J_b \text{ [kg·m}^2\text{]}$
<p>Inertia of Lifting Object by Pulley</p>	 <p> D: Diameter [mm] M_1: Mass of Cylinder [kg] J_1: Cylinder Inertia [kg·m²] J_2: Inertia due to the Object [kg·m²] M_2: Mass of Object [kg] J_w: Inertia [kg·m²] </p>	$J_w = J_1 + J_2 = \left(\frac{M_1 \cdot D^2}{8} + \frac{M_2 \cdot D^2}{4} \right) \times 10^{-6} \text{ [kg·m}^2\text{]}$

Sensors

Switches

Safety Components

Relays

Control Components

Automation Systems

Motion / Drives

Energy Conservation Support / Environment Measure Equipment

Power Supplies / In Addition

Others

Common

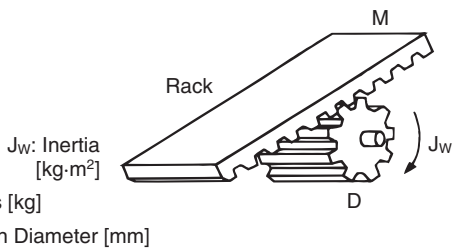
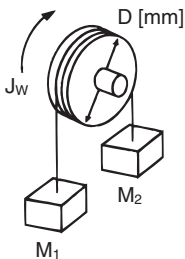
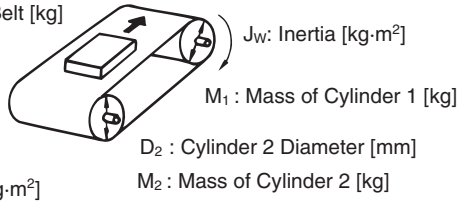
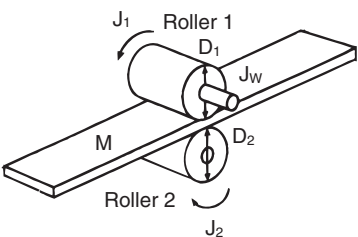
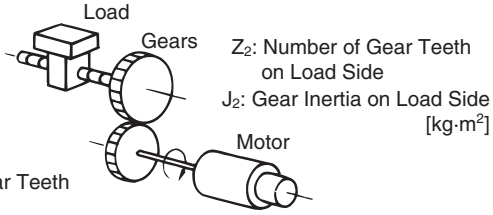
<p>Inertia of Rack and Pinion Movement</p>	 <p> J_w: Inertia [kg·m²] M: Mass [kg] D: Pinion Diameter [mm] </p>	$J_w = \frac{M \cdot D^2}{4} \times 10^{-6} \text{ [kg} \cdot \text{m}^2\text{]}$
<p>Inertia of Suspended Counterbalance</p>	 <p> J_w: Inertia [kg·m²] M₁: Mass [kg] M₂: Mass [kg] </p>	$J_w = \frac{D^2 (M_1 + M_2)}{4} \times 10^{-6} \text{ [kg} \cdot \text{m}^2\text{]}$
<p>Inertia when Carrying Object via Conveyor Belt</p>	 <p> M_3: Mass of Object [kg] M_4: Mass of Belt [kg] J_w: Inertia [kg·m²] M_1: Mass of Cylinder 1 [kg] M_2: Mass of Cylinder 2 [kg] </p> <p> J_1: Cylinder 1 Inertia [kg·m²] J_2: Inertia due to Cylinder 2 [kg·m²] J_3: Inertia due to the Object [kg·m²] J_4: Inertia due to the Belt [kg·m²] </p>	$J_w = J_1 + J_2 + J_3 + J_4$ $= \left(\frac{M_1 \cdot D_1^2}{8} + \frac{M_2 \cdot D_2^2}{8} \cdot \frac{D_1^2}{D_2^2} + \frac{M_3 \cdot D_1^2}{4} + \frac{M_4 \cdot D_1^2}{4} \right) \times 10^{-6} \text{ [kg} \cdot \text{m}^2\text{]}$
<p>Inertia where Work is Placed between Rollers</p>	 <p> J_w: System Inertia [kg·m²] J_1: Roller 1 Inertia [kg·m²] J_2: Roller 2 Inertia [kg·m²] D_1: Roller 1 Diameter [mm] D_2: Roller 2 Diameter [mm] M: Equivalent Mass of Work [kg] </p>	$J_w = J_1 + \left(\frac{D_1}{D_2} \right)^2 J_2 + \frac{M \cdot D_1^2}{4} \times 10^{-6} \text{ [kg} \cdot \text{m}^2\text{]}$
<p>Inertia of a Load Value Converted to Motor Shaft</p>	 <p> J_w: Load Inertia [kg·m²] Z_1: Number of Gear Teeth on Motor Side J_1: Gear Inertia on Motor Side [kg·m²] Z_2: Number of Gear Teeth on Load Side J_2: Gear Inertia on Load Side [kg·m²] J_L: Motor Shaft Conversion Load Inertia [kg·m²] Gear Ratio $G = Z_1/Z_2$ </p>	$J_L = J_1 + G^2 (J_2 + J_w) \text{ [kg} \cdot \text{m}^2\text{]}$

Load Torque Formulas

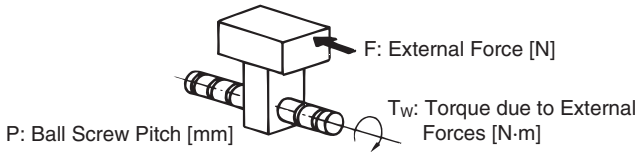
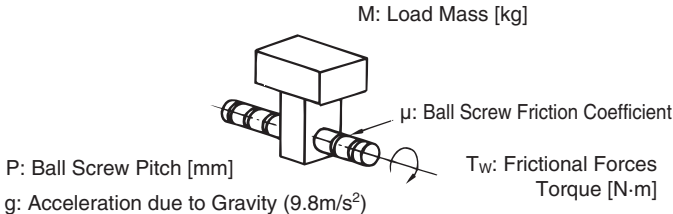
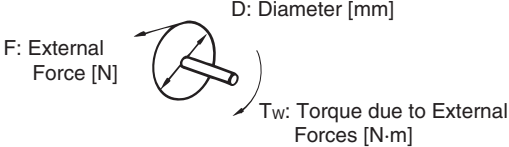
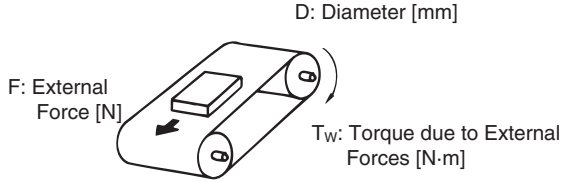
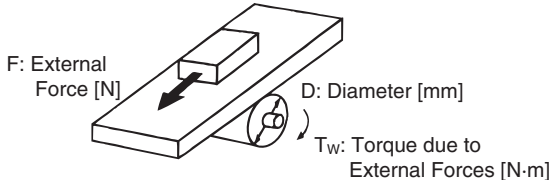
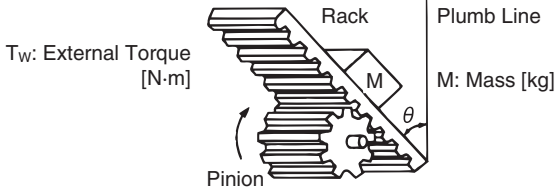
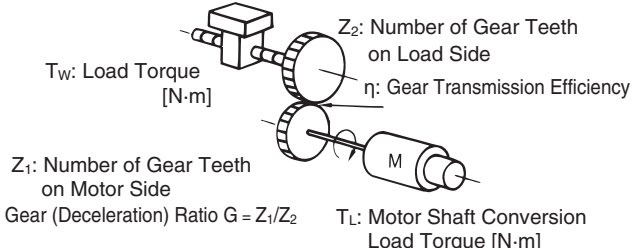
<p>Torque against external force</p>	 <p>F: External Force [N] P: Ball Screw Pitch [mm] T_w: Torque due to External Forces [N·m]</p>	$T_w = \frac{F \cdot P}{2\pi} \times 10^{-3} \text{ [N·m]}$
<p>Torque against frictional force</p>	 <p>M: Load Mass [kg] μ: Ball Screw Friction Coefficient P: Ball Screw Pitch [mm] g: Acceleration due to Gravity (9.8m/s^2) T_w: Frictional Forces Torque [N·m]</p>	$T_w = \mu M g \cdot \frac{P}{2\pi} \times 10^{-3} \text{ [N·m]}$
<p>Torque when external force is applied to a rotating object</p>	 <p>D: Diameter [mm] F: External Force [N] T_w: Torque due to External Forces [N·m]</p>	$T_w = F \cdot \frac{D}{2} \times 10^{-3} \text{ [N·m]}$
<p>Torque of an object on the conveyer belt to which the external force is applied</p>	 <p>D: Diameter [mm] F: External Force [N] T_w: Torque due to External Forces [N·m]</p>	$T_w = F \cdot \frac{D}{2} \times 10^{-3} \text{ [N·m]}$
<p>Torque of an object to which the external force is applied by Rack and Pinion</p>	 <p>F: External Force [N] D: Diameter [mm] T_w: Torque due to External Forces [N·m]</p>	$T_w = F \cdot \frac{D}{2} \times 10^{-3} \text{ [N·m]}$
<p>Torque when work is lifted at an angle.</p>	 <p>T_w: External Torque [N·m] Rack Pinion Plumb Line M: Mass [kg] g: Acceleration due to Gravity (9.8m/s^2) D: Diameter [mm]</p>	$T_w = M g \cdot \cos\theta \cdot \frac{D}{2} \times 10^{-3} \text{ [N·m]}$
<p>Torque of a Load Value Converted to Motor Shaft</p>	 <p>T_w: Load Torque [N·m] Z_2: Number of Gear Teeth on Load Side η: Gear Transmission Efficiency Z_1: Number of Gear Teeth on Motor Side Gear (Deceleration) Ratio $G = Z_1/Z_2$ T_L: Motor Shaft Conversion Load Torque [N·m]</p>	$T_L = T_w \cdot \frac{G}{\eta} \text{ [N·m]}$

Sensors

Switches

Safety Components

Relays

Control Components

Automation Systems

Motion / Drives

Energy Conservation Support / Environment Measure Equipment

Power Supplies / In Addition

Others

Common

Acceleration/Deceleration Torque Formula

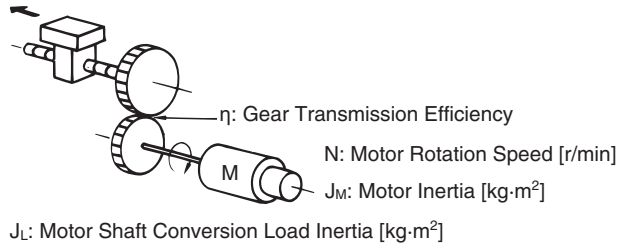

Acceleration/Deceleration Torque (T_A)

$$T_A = \frac{2\pi N}{60t_A} \left(J_M + \frac{J_L}{\eta} \right) [\text{N}\cdot\text{m}]$$

Speed (Rotation Speed)

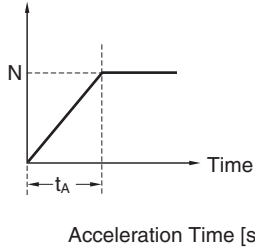

N: Rotation Speed [r/min]

T_A : Acceleration/Deceleration Torque [N·m]

Calculation of Maximum Momentary Torque, Effective Torque

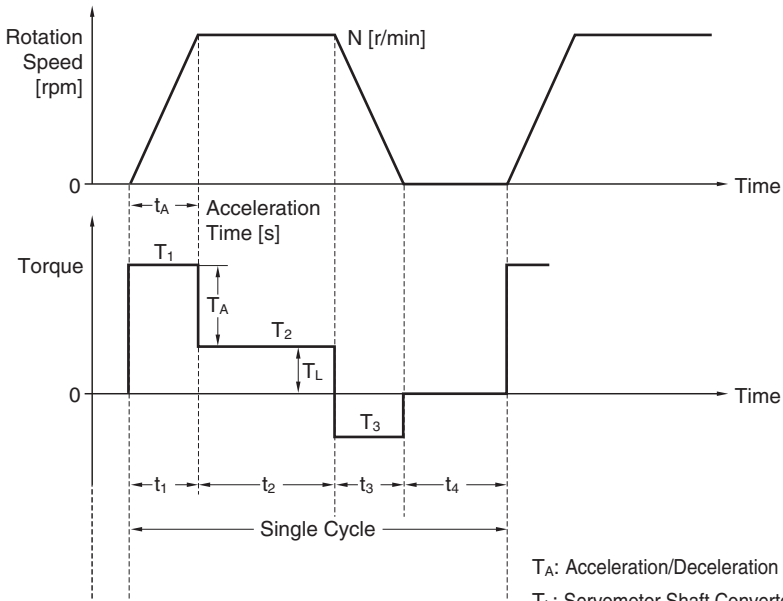

T_A : Acceleration/Deceleration Torque [N·m]
 T_L : Servomotor Shaft Converted Load Torque [N·m]
 T_1 : Maximum Momentary Torque [N·m]
 T_{rms} : Effective Torque [N·m]

Maximum Momentary Torque (T_1)

$$T_1 = T_A + T_L [\text{N}\cdot\text{m}]$$

Effective Torque (T_{rms})

$$T_{rms} = \sqrt{\frac{T_1^2 \cdot t_1 + T_2^2 \cdot t_2 + T_3^2 \cdot t_3}{t_1 + t_2 + t_3 + t_4}} [\text{N}\cdot\text{m}]$$

$$T_2 = T_L [\text{N}\cdot\text{m}]$$

$$T_3 = T_L - T_A [\text{N}\cdot\text{m}]$$

$$t_1 = t_A [\text{N}\cdot\text{m}]$$

Positioning Accuracy

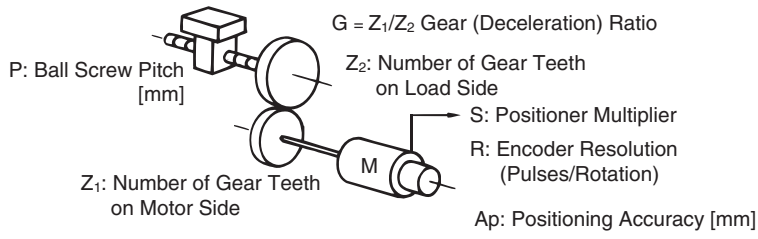

Positioning Accuracy (A_p)

$$A_p = \frac{P \cdot G}{R \cdot S} \text{ [mm]}$$

Straight Line Speed and Motor Rotation Speed

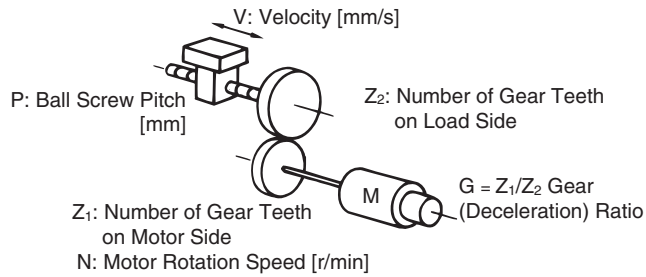

Motor Rotations

$$N = \frac{60V}{P \cdot G} \text{ [r/min]}$$

Sensors

Switches

Safety Components

Relays

Control Components

Automation Systems

Motion / Drives

Energy Conservation Support / Environment Measure Equipment

Power Supplies / In Addition

Others

Common

Sample Calculations

1. Machinery Selection

- Load Mass $M = 5$ [kg]
- Ball Screw Pitch $P = 10$ [mm]
- Ball Screw Diameter $D = 20$ [mm]
- Ball Screw Mass $M_B = 3$ [kg]
- Ball Screw Friction Coefficient $\mu = 0.1$
- Since there is no decelerator, $G = 1, \eta = 1$

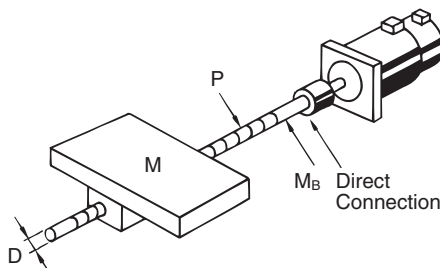

2. Determining Operating Pattern

- One Speed Change
- Velocity for a Load Travel $V = 300$ [mm/s]
- Strokes $L = 360$ [mm]
- Stroke Travel Time $t_S = 1.4$ [s]
- Acceleration/Deceleration Time $t_A = 0.2$ [s]
- Positioning Accuracy $A_p = 0.01$ [mm]

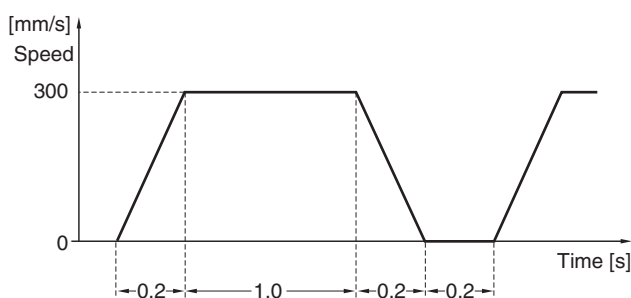

3. Calculation of Motor Shaft Conversion Load Inertia

Ball screw Inertia J_B	$J_B = \frac{M_B D^2}{8} \times 10^{-6}$	$J_B = \frac{3 \times 20^2}{8} \times 10^{-6} = 1.5 \times 10^{-4}$ [kg·m ²]
Load Inertia J_W	$J_W = M \left(\frac{P}{2\pi} \right)^2 \times 10^{-6} + J_B$	$J_W = 5 \times \left(\frac{10}{2 \times 3.14} \right)^2 \times 10^{-6} + 1.5 \times 10^{-4} = 1.63 \times 10^{-4}$ [kg·m ²]
Motor Shaft Conversion Load Inertia J_L	$J_L = G^2 \times (J_W + J_2) + J_1$	$J_L = J_W = 1.63 \times 10^{-4}$ [kg·m ²]

4. Load Torque Calculation

Torque against Friction Torque T_W	$T_W = \mu M g \frac{P}{2\pi} \times 10^{-3}$	$T_W = 0.1 \times 5 \times 9.8 \times \frac{10}{2 \times 3.14} \times 10^{-3} = 7.8 \times 10^{-3}$ [N·m]
Motor Shaft Conversion Load Torque T_L	$T_L = \frac{G}{\eta} \cdot T_W$	$T_L = T_W = 7.8 \times 10^{-3}$ [N·m]

5. Calculation of Rotation Speed

Rotations N	$N = \frac{60V}{P \cdot G}$	$N = \frac{60 \times 300}{10 \times 1} = 1800$ [r/min]
---------------------------------	-----------------------------	--

6. Motor Temporary Selection [In case OMNUC U Series Servomotor is temporarily selected]

The Rotor/Inertia of the selected Servomotor is more than 1/30* of a load	$J_M \geq \frac{J_L}{30}$	$\frac{J_L}{30} = \frac{1.63 \times 10^{-4}}{30} = 5.43 \times 10^{-6}$ [kg·m ²] Temporarily selected Model R88M-U20030 ($J_M = 1.23 \times 10^{-5}$).
80% of the Rated Torque of the selected Servomotor is more than the load torque of the Servomotor shaft conversion value	$T_M \times 0.8 > T_L$	Rated Torque for R88M – U20030 Model from TM = 0.637 [N·m] $T_M = 0.637$ [N·m] $\times 0.8 > T_L = 7.8 \times 10^{-3}$ [N·m]

* Note that this value changes according to the Series.

7. Calculation of Acceleration/Deceleration Torque

Acceleration/Deceleration Torque T_A	$T_A = \frac{2\pi \cdot N}{60t_A} \left(J_M + \frac{J_L}{\eta} \right)$	$T_A = \frac{2\pi \times 1800}{60 \times 0.2} \times \left(1.23 \times 10^{-5} + \frac{1.63 \times 10^{-4}}{1.0} \right) = 0.165 \text{ [N}\cdot\text{m]}$
--	--	---

8. Calculation of Maximum Momentary Torque, Effective Torque

Required Max. Momentary Torque is

$$T_1 = T_A + T_L = 0.165 + 0.0078 = 0.173 \text{ [N}\cdot\text{m]}$$

$$T_2 = T_L = 0.0078 \text{ [N}\cdot\text{m]}$$

$$T_3 = T_L - T_A = 0.0078 - 0.165 = -0.157 \text{ [N}\cdot\text{m]}$$

Effective Torque Trms is

$$Trms = \sqrt{\frac{T_1^2 \cdot t_1 + T_2^2 \cdot t_2 + T_3^2 \cdot t_3}{t_1 + t_2 + t_3 + t_4}}$$

$$= \sqrt{\frac{0.173^2 \times 0.2 + 0.0078^2 \times 1.0 + 0.157^2 \times 0.2}{0.2 + 1.0 + 0.2 + 0.2}}$$

$$= 0.0828 \text{ [N}\cdot\text{m]}$$

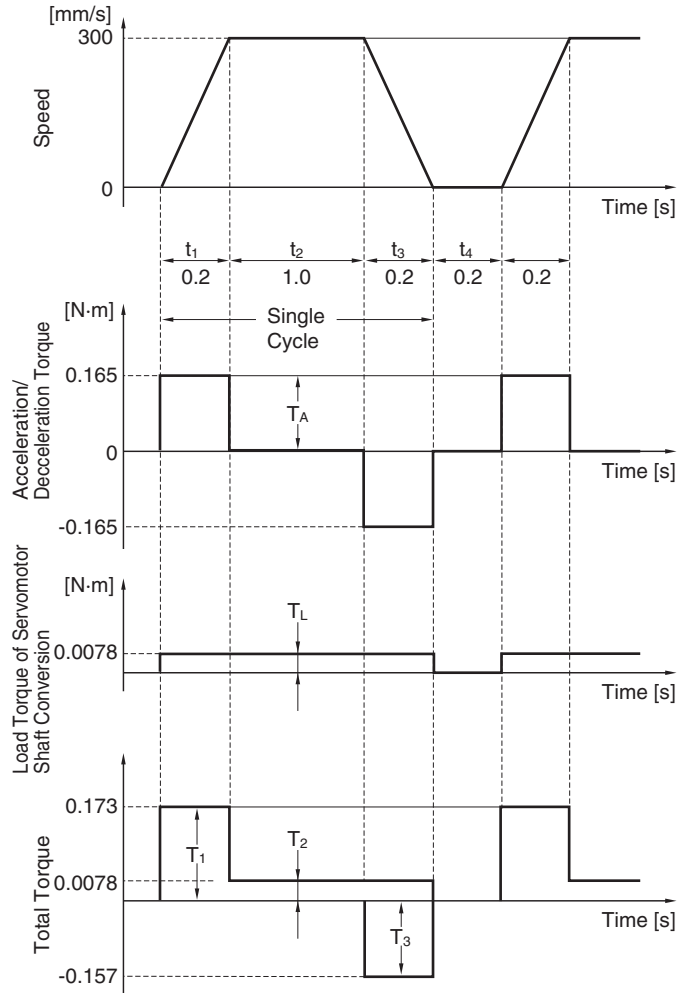

9. Result of Examination

Load Inertia	[Load Inertia $J_L = 1.63 \times 10^{-4} \text{ [kg}\cdot\text{m}^2]$] \leq [Motor Rotor Inertia $J_M = 1.23 \times 10^{-5}$] \times [Applied Inertia = 30]	Conditions Satisfied
Effective Torque	[Effective Torque $Trms = 0.0828 \text{ [N}\cdot\text{m]}$] $<$ [Servomotor Rated Torque $0.637 \text{ [N}\cdot\text{m}] \times 0.8$]	Conditions Satisfied
Maximum Momentary Torque	[Maximum Momentary Torque $T_1 = 0.173 \text{ [N}\cdot\text{m}]$] $<$ [Servomotor Maximum Momentary Torque $1.91 \text{ [N}\cdot\text{m}] \times 0.8$]	Conditions Satisfied
Maximum Rotation Speed	[Maximum Rotations Required $N = 1800 \text{ [r/min]}$] \leq [Servomotor Rated Rotation Speed 3000 [r/min]]	Conditions Satisfied
Encoder Resolution	The encoder resolution when the positioner multiplication factor is set to 1 is $R = \frac{P \cdot G}{A_p \cdot S} = \frac{10 \times 1}{0.01 \times 1} = 1000 \text{ [Pulses/Rotations]}$ The encoder specification of U Series 2048 [pulses/rotation] should be set 1000 with the Encoder Dividing Rate Setting.	Conditions Satisfied

Note: This example omits calculations for the regenerative energy, operating conditions, or positioner characteristics.

- Sensors
- Switches
- Safety Components
- Relays
- Control Components
- Automation Systems
- Motion / Drives
- Energy Conservation Support / Environment Measure Equipment
- Power Supplies / In Addition
- Others
- Common

Maintenance

Servomotors and Servo Drives contain many components and will operate properly only when each of the individual components is operating properly.

Some of the electrical and mechanical components require maintenance depending on application conditions. In order to ensure proper long-term operation of Servomotors and Drives, periodic inspection and part replacement is required according to the life of the components.

(From the "Recommendations for Periodic Inspection of Inverters", published by JEMA)

The periodic maintenance cycle depends on the installation environment and application conditions of the Servomotor or Servo Drive. Recommended maintenance times are listed below for Servomotors and Servo Drives. Use these for reference in determining actual maintenance schedules.

For Servomotors and Servo Drives maintenance, please check the "User Manual (Chapter on Periodic Maintenance)" for each Series.

Servo Drive

(including Power Supply unit and Regeneration Resistor)

Among the components used in the Servo Drive, aluminum analytical capacitors and Axle fans in particular require periodic maintenance.

The life of aluminum analytical capacitors is greatly affected by the ambient operating temperature and the load conditions of Servomotor operation.

Generally speaking, an increase of 10°C in the ambient operating temperature will reduce capacitor life by 50%.

Recommended maintenance times are listed below for each of the Series.

- **OMNUC G5 Series**

Aluminum analytical capacitors.....28,000 hours
(Ambient operating temperature 55°C, output of the rated operation [rated torque])
Axle fan.....10,000 to 30,000 hours
(At an ambient Servo Drive operating temperature of 40°C or below)

- **Smart Step 2 Series**

Aluminum analytical capacitors.....50,000 hours
(Ambient operating temperature 40°C, 80% output of the rated operation [rated torque])
Axle fan.....30,000 hours
(At an ambient Servo Drive operating temperature of 40°C and an ambient humidity of 65%)

- **OMNUC G Series**

Aluminum analytical capacitors.....28,000 hours
(Ambient operating temperature 55°C, output of the rated operation [rated torque])
Axle fan.....10,000 to 30,000 hours
(At an ambient Servo Drive operating temperature of 40°C or below)

Please follow the instructions in the user manual for installation.

We recommend that ambient operating temperature and the power ON time be reduced as much as possible to lengthen the maintenance intervals for Servo Drives.

If the Servomotor or Servo Drive is not to be used for a long time, or if they are to be used under conditions worse than those described above, a periodic inspection schedule of five years is recommended.

Please consult with OMRON to determine whether or not components need to be replaced.

Servomotor

Among the components used by the Servomotor, Aluminum Analytical Capacitors, Bearings, Oil seal and Brush require periodic maintenance. Their life will depend on such factors as the number of rotations used for, the temperature, and the load on bearings. Recommended maintenance times are listed below for each of the Series.

- **OMNUC G5 Series**

Bearings 20,000 hours
Oil Seals 5,000 hours

- **Smart Step 2 Series**

Bearings 20,000 hours
Oil Seals 5,000 hours

- **OMNUC G Series**

Bearings 20,000 hours
Oil Seals 5,000 hours

Application Conditions: Ambient Servomotor operating temperature of 40°C, within allowable shaft load, rated operation (rated torque and r/min), installed as described in operation manual.